

ZENDRA

ETL CE III F IP20

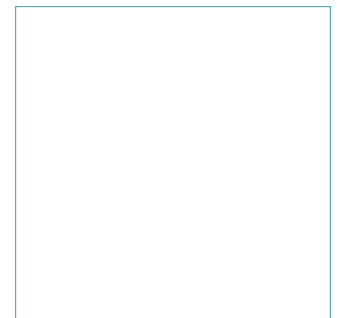

Recessed hole / Trou d'encastrement:

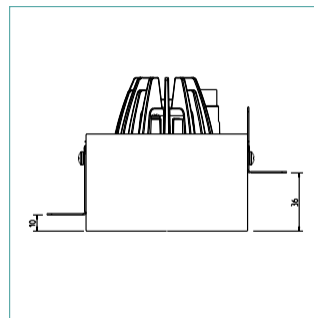
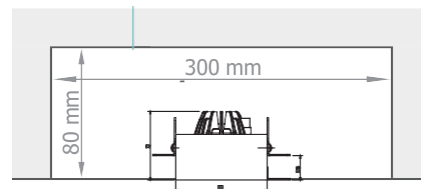

DESCRIPTION

Zendra is a professional square directional trimless LED luminaire, with a deep recessed COB LED light source and features high efficiency reflector technology for excellent glare control and uniformity. Zendra offers a choice of three colour temperatures as standard (2700K, 3000K and 4000K) and delivers 90 CRI for excellent colour rendering. With binning-free LEDs carefully selected from two-step MacAdam's ellipses, colour consistency is assured throughout the unonovesette portfolio.

DESCRIPTION

Zendra est un projecteur encastré à LED professionnel, avec une position en retrait de la source de lumière à LED COB. Grâce à la technologie des réflecteurs, il offre une excellente uniformité et un contrôle de l'éblouissement, offrant une rotation verticale de $\pm 24^\circ$. Zendra offre un choix de trois températures de couleur standard (2700K, 3000K et 4000K), 90 IRC pour un excellent rendu des couleurs. Binning-free et 2 step MacAdam garantissent la cohérence des couleurs dans toutes les versions fournies par unonovesette.

OPTICS / FAISCEAU:

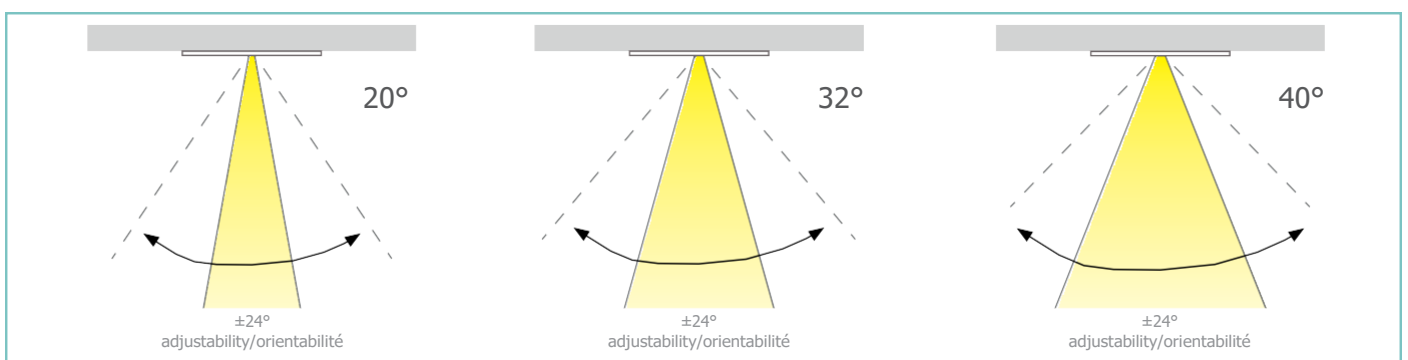



ZEN DRA



TECHNICAL SHEET / FICHE PRODUIT:

Body:	Die-cast aluminium	Corps:	Aluminium moulé sous pression
Finishes:	White RAL 9003 / Black RAL 9005	Finitions:	Blanc RAL 9003 / Noir RAL 9005
Installation:	Housing box	Installation:	Boîtier d'encastrement
Power supply cables:	30 cm PVC + PVC 2x0,5 mm ²	Câbles d'alimentation:	30 cm PVC + PVC 2x0,5 mm ²
Power supply:	Constant current 350mA Max	Alimentation:	Courant constant 350mA Max
Power consumption:	12,9 Watt Max	Puissance absorbée:	12,9 Watt Max
CRI:	>90	IRC Indice de Rendu des Couleurs:	>90
Bin selection:	Binning free 2 step MacAdam's	Sélection du bin:	Binning free 2 step MacAdam's
Lumenoutput (source):	1154 lm (3000K) / 1045 lm - 28 lm (DTW)	Flux de la source:	1154 lm (3000K) / 1045 lm - 28 lm (DTW)
Operating temperature:	-20°C +50°C	Température de fonctionnement:	-20 °C +50 °C
IP rating:	IP20	Indice de protection:	IP20
Insulation class:	Class III	Classe d'isolation:	Classe III
Weight:	610 g	Poids:	610 g
Optics:	20° / 32° / 40° / (20° / 40° DTW)	Optiques:	20° / 32° / 40° / (20° / 40° DTW)
Energy rating:	A++	Classe d'efficacité énergétique:	A++
LED colour temperature:	2700K / 3000K / 4000K / (3000K-1800K DTW)	Couleur LED:	2700K / 3000K / 4000K / (3000K-1800K DTW)
Lifetime LED:	100000 hrs	Durée moyenne LED:	100000 hrs
Photo biological risk:	RG0 / RG1	Sécurité photobiologique:	RG0 / RG1

FINISHES / FINITIONS:

 White RAL 9003
Blanc RAL 9003

 Black RAL 9005
Noir RAL 9005

PRODUCT CODE/CODE PRODUIT:

ZEN = ZEN DRA	Select one component from each column to specify a complete configuration: Sélectionner un composant pour chaque colonne pour une configuration complète:		
	LED colour / Couleur LED	Optics / Faisceau	Finish / Finitions
	27 = 2700K 30 = 3000K 40 = 4000K DW = Dim to warm	N = 20° (20° DTW) M = 32° W = 40° (40° DTW)	01 = White RAL 9003 / Blanc RAL 9003 02 = Black RAL 9005 / Noir RAL 9005

Standard configuration example/
Exemple de configuration standard:

ZEN.30.N.01 Zendra 3000K 20° optics white / blanc



POWER SUPPLIES 350mA CONSTANT CURRENT / ALIMENTATEUR COURANT CONSTANT 350mA:

On / Off

Code / Code	Input	I Out	V Out	Watt	IP	#Zendra
PSU.CX.003	110÷240V / 50/60 Hz	350mA	47 V	24	IP20	Max 1
PSU.CX.004	110÷240V / 50/60 Hz	350mA	43 V	20	IP20	Max 1

Dimmable / Gradable

Code / Code	Input	I Out	V Out	Watt	IP	#Zendra
PSU.CX.001 1-10V/PUSH	100÷240V / 50/60 Hz	350mA	47 V	15	IP20	Max 1
PSU.CX.002 DALI	100÷240V / 50/60 Hz	350mA	47 V	15	IP20	Max 1
PSU.CC.022 DTW DALI	220÷240V / 47/53 Hz	350mA	40 V	20	IP20	Max 1

PHOTOMETRICS / COURVES PHOTOMETRIQUE:

20° - 12,9 Watt

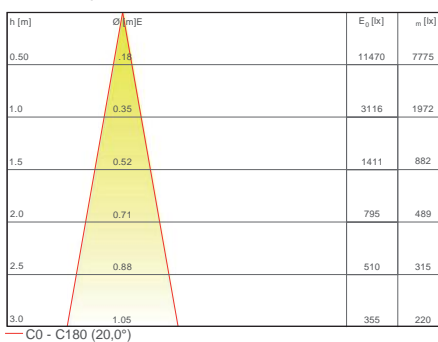

32° - 12,9 Watt

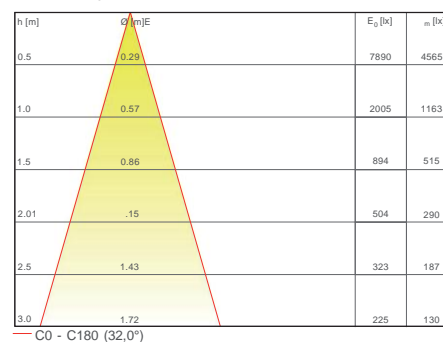

40° - 12,9 Watt

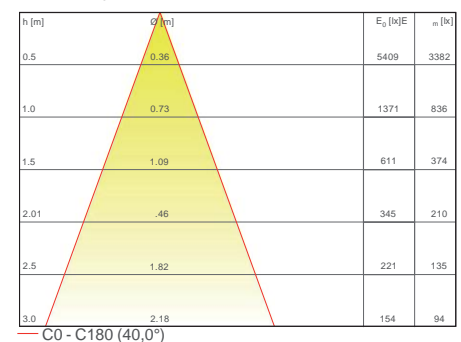

ACCESSORIES / ACCESSOIRES



Honeycomb louver
Grille nid d'abeille
ACC.001



Micro prismatic diffuser
Diffuseur micro prismatique
ACC.002