

 VARIO 40

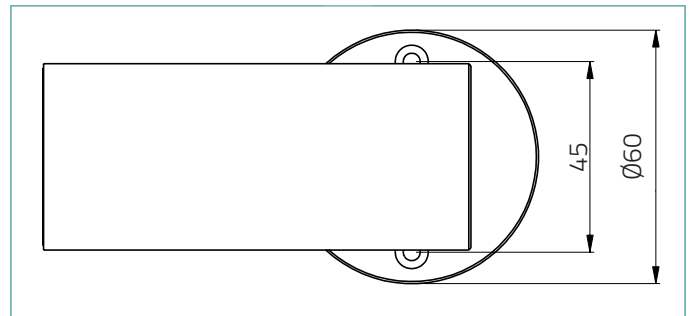
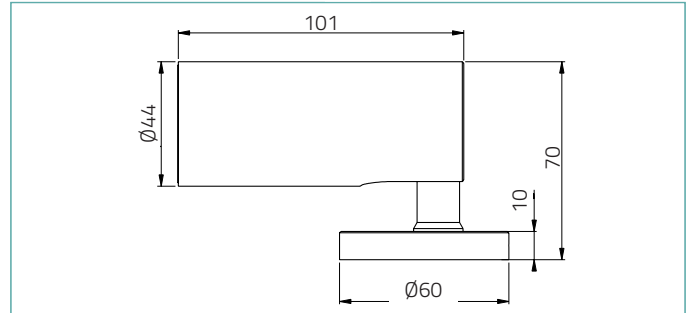

DESCRIPTION

Vario 40 is an extremely efficient compact LED projector, designed for optical excellence and engineered for complete resilience. Vario 40 offers a choice of four colour temperatures as standard (2200K, 2700K, 3000K and 4000K) and delivers 90 CRI for excellent colour rendering, and with binning-free LEDs carefully selected from two-step MacAdam's ellipses, colour consistency is assured throughout the unonovesette portfolio. With a deep recess of the in-house designed PCB, Vario 40 offers excellent glare control.

DESCRIZIONE

Vario 40 è un apparecchio a LED dalle dimensioni compatte estremamente efficiente. Ideato con un'ottica eccellente e progettato per una completa flessibilità, Vario 40 offre una scelta fra quattro temperature di colore standard (2200K, 2700K, 3000K e 4000K) tutte con CRI maggiore di 90 per una eccellente resa cromatica. Binningfree e due-step MacAdam's ellipses LED, assicurano consistenza del colore in tutte le versioni previste da unonovesette. Con l'elettronica progettata internamente e ben posizionata, Vario 40 offre un eccellente controllo dell'abbagliamento.

OPTICS / OTTICHE:

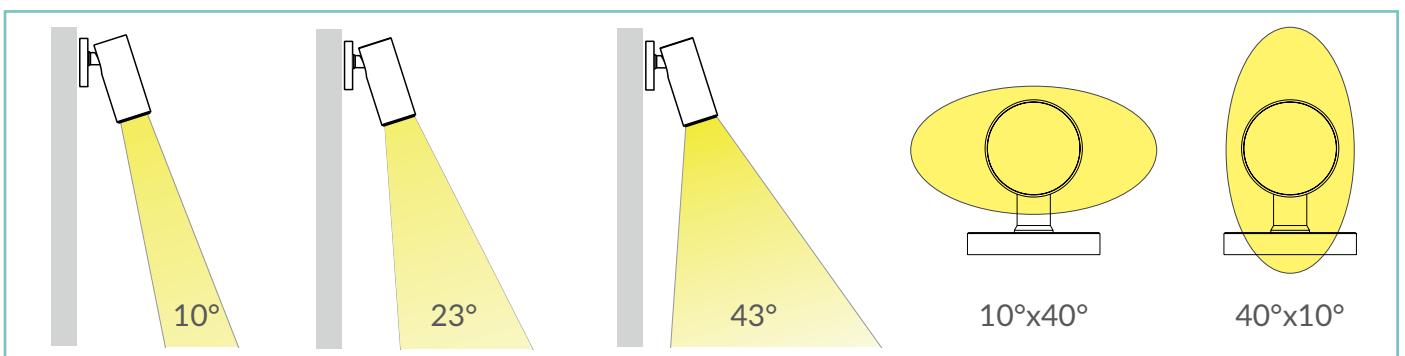

VARIO 40



TECHNICAL DATA / SCHEDA PRODOTTO:

Body:	Anodized aluminium 6026 / Machined aged brass	Corpo:	Alluminio anodizzato 6026 / Ottone anticato tornito
Glass:	Extra clear tempered glass 3 mm	Vetro:	Vetro temperato extra chiaro 3 mm
Finishes:	Natural anodized / Black anodized / Aged solid brass	Finiture:	Anodizzato naturale / Anodizzato nero / Ottone anticato
Installation:	Surface mounted / Spike / Tree strap	Fissaggio:	Su superficie / Picchetto / Cintura per albero
Power supply cables:	100 cm NS20N PCP 2x0,5 mm ²	Cavo di alimentazione:	100 cm NS20N PCP 2x0,5 mm ²
Power supply:	Constant voltage 24Vdc	Alimentazione:	Tensione costante 24vdc
Power consumption:	2,6 Watt / 3,6 Watt	Potenza assorbita:	2,6 Watt / 3,6 Watt
CRI:	>90	CRI:	>90
Bin selection:	Binning free 2 step MacAdam's	Selezione bin:	Binning free 2 step MacAdam's
Lumen Output: (source)	210 lm / 283 lm (3000K)	Flusso luminoso (sorgente):	210 lm / 283 lm (3000K)
Operating temperature:	-20°C +50°C	Temperatura di funzionamento:	-20°C +50°C
IP rating:	IP66	Grado di protezione:	IP66
Insulation class:	Class III	Classe d'isolamento:	Classe III
Impact resistance:	IK07	Protezione impatto:	IK07
Weight:	270 g	Peso:	270 g
Optics:	10° / 23° / 43° / 10°x 40° / 40°x10°	Ottiche:	10° / 23° / 43° / 10°x 40° / 40°x10°
Energy rating:	A++	Energy rating:	A++
LED colour temperature:	2200K / 2700K / 3000K / 4000K	Temperatura colore LED:	2200K / 2700K / 3000K / 4000K
Lifetime LED:	100000 hrs	Vita media LED:	100000 hrs
Photo biological risk:	RG0 / RG1	Rischio fotobiologico:	RG0 / RG1

FINISHES / FINITURE:

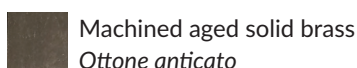
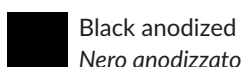
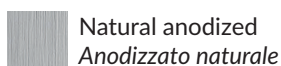

PRODUCT CODE / CODICE PRODOTTO:

V40 = VARIO 40		Select one component from each column to specify a complete configuration/ Selezionare un componente per ogni colonna per la configurazione completa:		
	LED colour / Colore LED	Optics / Ottiche	Finish/Finiture	Watt
	22 = 2200K	N = 10°	05 = Black anodized/ Anodizzato nero	02 = 2,6 W
	27 = 2700K	M = 23°	07 = Natural anodized / Anodizzato naturale	04 = 3,6 W
	30 = 3000K	W = 43°	10 = Aged brass / Ottone anticato	
	40 = 4000K	E = 10°x 40° X = 40°x10°		

Standard configuration example/
Esempio di configurazione standard:

V40.30.N.07.04 Vario 40 3000K 10° optics natural anodized / anodizzato naturale 3,6 Watt

VARIO 40



POWER SUPPLIES 24Vdc CONSTANT VOLTAGE / ALIMENTATORE TENSIONE COSTANTE 24Vdc:

On / Off

Code / Codice	Input	I Out	V Out	Watt	IP	#Vario 40
PSU.CX.004	110÷240V / 50/60 Hz	0,9 A	24Vdc	20	IP20	Max 4
PSU.CV.005	90÷305V / 47/63 Hz	1 A	24Vdc	25	IP67	Max 5
PSU.CV.006	90÷305V / 47/63 Hz	2,5 A	24Vdc	60	IP67	Max 12
PSU.CV.007	90÷305V / 47/63 Hz	3,75 A	24Vdc	90	IP67	Max 20

Control gear / Elettronica di controllo

Code / Codice	Input	I Out	V Out	Watt	IP	#Vario 40
CGE.004 - 0/1-10V	24Vdc	6,5 A	24Vdc	156	IP20	Max 40
CGE.017 - DALI	24Vdc	6,5 A	24Vdc	156	IP20	Max 40
CGE.017.IP - DALI	24Vdc	6,5 A	24Vdc	156	IP67	Max 40
CGE.020 - DMX	24Vdc	6,5 A	24Vdc	156	IP20	Max 40

PHOTOMETRICS / CURVE FOTOMETRICHE:

10° - 3,6 Watt

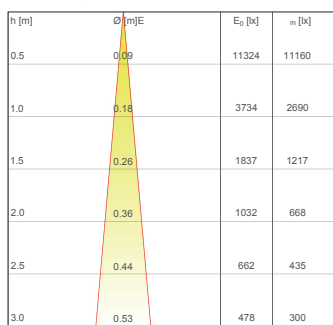

— C0 - C180 (10,0°)

23° - 3,6 Watt

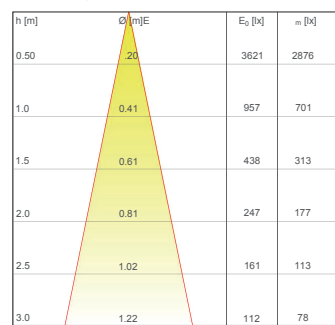

— C0 - C180 (23,0°)

43° - 3,6 Watt

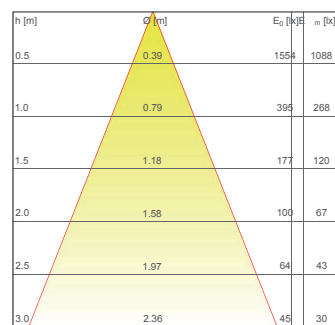





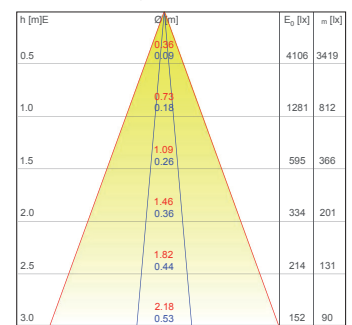

— C0 - C180 (43,0°)

40°x10° - 3,6 Watt

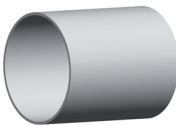

— C0 - C180 (45,0°) — C90 - C270 (10,0°)

ACCESSORIES / ACCESSORI

 <p>Honeycomb louver Schermo alveolare ACC.109</p>	 <p>Tree strap Fascia per alberi ACC.082</p>	 <p>Snoot 45° Paraluce 45° ACC.011</p>	 <p>Base Basetta ACC.076</p>
 <p>Ground spike Picchetto ACC.075</p>	 <p>Snoot tube Paraluce tubo ACC.106</p>	 <p>Cable Cavo 5m 10m 15m 20m 25m</p>	<p>CV00037 CV00040 CV00041 CV00042 CV00043</p>