

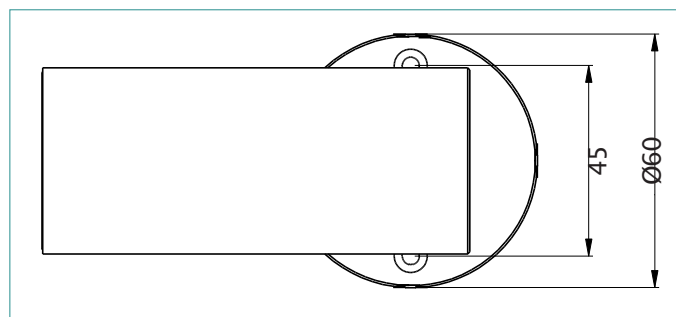

VARIO 40

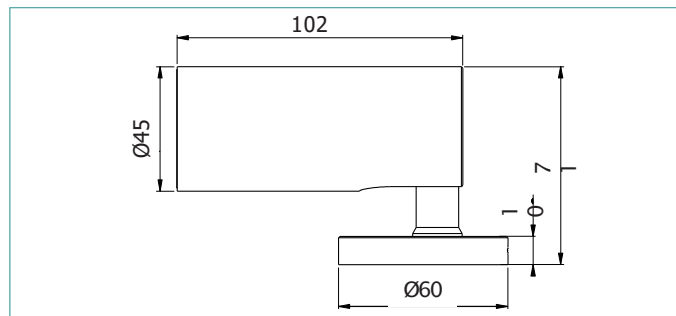

DESCRIPTION

Vario 40 is an extremely efficient compact LED projector, designed for optical excellence and engineered for complete resilience. Vario 40 offers a choice of four colour temperatures as standard (2200K, 2700K, 3000K and 4000K) and delivers 90 CRI for excellent colour rendering, and with binning-free LEDs carefully selected from two-step MacAdam's ellipses, colour consistency is assured throughout the unonovesette portfolio. With a deep recess of the in-house designed PCB, Vario 40 offers excellent glare control.

DESCRIPTION

Le Vario 40 est un projecteur LED compact extrêmement efficace, conçu avec d'excellentes optiques et pour une flexibilité totale. Le Vario 40 offre un choix de quatre températures de couleur en standard (2200K, 2700K, 3000K et 4000K) avec un IRC de 90 pour un excellent rendu des couleurs Binning-free et 2 step MacAdam garantissent la cohérence des couleurs dans toutes les versions fournies par unonovesette. Avec un renforcement profond du PCB conçu en interne, le Vario 40 offre un excellent contrôle de l'éblouissement.

OPTICS / FAISCEAU:

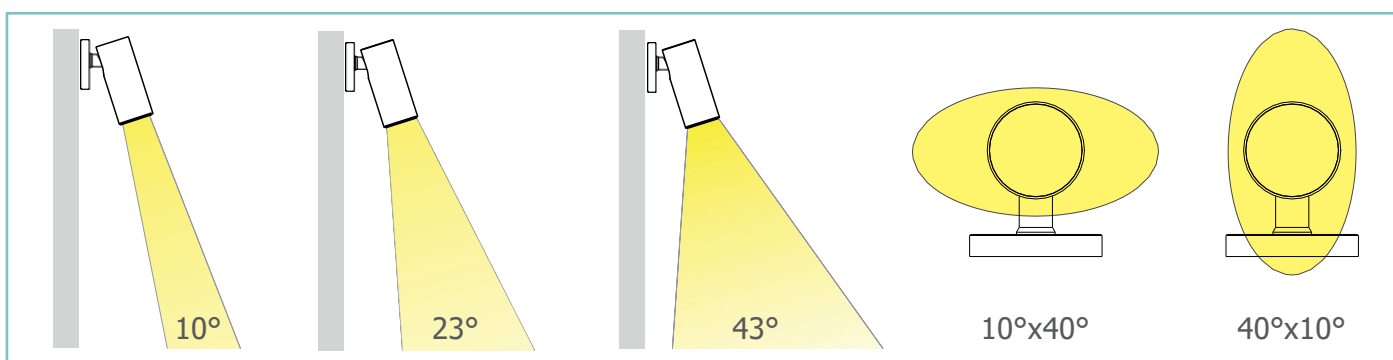



VARIO 40



TECHNICAL SHEET / FICHE PRODUIT:

Body:	Anodized aluminium 6026 / Machined aged brass	Corps:	Anodisé naturel 6026 / Laiton vieilli tourné
Glass:	Extra clear tempered glass 3 mm	Verre:	Verre temperé extra clair 3 mm
Finishes:	Natural anodized / Black anodized / Aged solid brass	Finitions:	Anodisé naturel / Anodisé Noir / Laiton vieilli
Installation:	Surface mounted / Spike / Tree strap	Installation:	Surface / Piquet / Fixation aux arbres
Power supply cables:	130 cm NS20N PCP 2x0,5 mm ²	Câbles d'alimentation:	130 cm NS20N PCP 2x0,5 mm ²
Power supply:	Constant voltage 24Vdc	Alimentation:	Tension constante 24vdc
Power consumption:	2,6 Watt / 3,6 Watt	Puissance absorbée:	2,6 Watt / 3,6 Watt
CRI:	>90	IRC Indice de Rendu des Couleurs:	>90
Bin selection:	Binning free 2 step MacAdam's	Sélection du bin:	Binning free 2 step MacAdam's
Lumen Output: (source)	210 lm / 283 lm (3000K)	Flux de la source:	210 lm / 283 lm (3000K)
Operating temperature:	-20°C +50°C	Température de fonctionnement:	-20°C +50°C
IP rating:	IP66	Indice de protection:	IP66
Insulation class:	Class III	Classe d'isolation:	Classe III
Impact resistance:	IK07	Indice de résistance:	IK07
Weight:	270 g	Poids:	270 g
Optics:	10° / 23° / 43° / 10°x 40° / 40°x10°	Optiques:	10° / 23° / 43° / 10°x 40° / 40°x10°
Energy rating:	A++	Energy rating:	A++
LED colour temperature:	2200K / 2700K / 3000K / 4000K	Couleur LED:	2200K / 2700K / 3000K / 4000K
Lifetime LED:	100000 hrs	Durée moyenne LED:	100000 hrs
Photo biological risk:	RG0 / RG1	Sécurité photobiologique:	RG0 / RG1

FINISHES / FINITIONS:

	Natural anodized <i>Anodisé naturel</i>
	Black anodized <i>Anodisé noir</i>
	Machined aged solid brass <i>Laiton vieilli</i>

PRODUCT CODE/CODE PRODUIT:

V40 = VARIO 40	Select one component from each column to specify a complete configuration: <i>Sélectionner un composant pour chaque colonne pour une configuration complète:</i>			
	LED colour / Couleur LED	Optics / Faisceau	Finish / Finitions	Watt
	22 = 2200K	N = 10°	05 = Black anodized / Anodisé Noir	02 = 2,6 W
	27 = 2700K	M = 23°	07 = Natural anodized / Anodisé naturel	04 = 3,6 W
	30 = 3000K	W = 43°	10 = Aged brass / Laiton vieilli	
	40 = 4000K	E = 10°x 40° X = 40°x10°		

Standard configuration example/
Exemple de configuration standard:

V40.30.N.07.04 Vario 40 3000K 10° optics natural anodized / Anodisé naturel 3,6 Watt

VARIO 40



POWER SUPPLIES 24Vdc CONSTANT VOLTAGE / ALIMENTATEUR TENSION CONSTANTE 24Vdc:

On / Off

Code / Code	Input	I Out	V Out	Watt	IP	#Vario 40
PSU.CX.004	110 ÷ 240V / 50/60 Hz	0,9 A	24Vdc	20	IP20	Max 4
PSU.CV.005	90 ÷ 305V / 47/63 Hz	1 A	24Vdc	25	IP67	Max 5
PSU.CV.006	90 ÷ 305V / 47/63 Hz	2,5 A	24Vdc	60	IP67	Max 12
PSU.CV.007	90 ÷ 305V / 47/63 Hz	3,75 A	24Vdc	90	IP67	Max 20

Control gear / Système de control

Code / Code	Input	I Out	V Out	Watt	IP	#Vario 40
CGE.004 - 0/1-10V	24Vdc	6,5 A	24Vdc	156	IP20	Max 40
CGE.017 - DALI	24Vdc	6,5 A	24Vdc	156	IP20	Max 40
CGE.017.IP - DALI	24Vdc	6,5 A	24Vdc	156	IP67	Max 40
CGE.020 - DMX	24Vdc	6,5 A	24Vdc	156	IP20	Max 40

PHOTOMETRICS / COURVES PHOTOMETRIQUE:

10° - 3,6 Watt

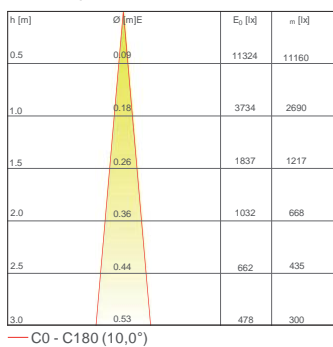

23° - 3,6 Watt

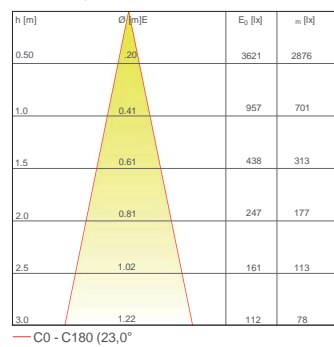



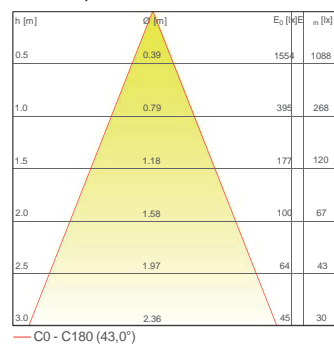

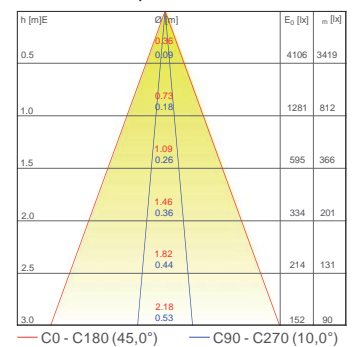

43° - 3,6 Watt



40°x10° - 3,6 Watt

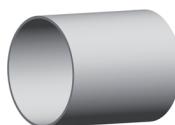

ACCESSORIES / ACCESSOIRES

 Honeycomb louver Grille nid d'abeille ACC.109	 Tree strap Fixation aux arbres ACC.082	 Snoot 45° Casquette 45° ACC.011	 Base Base de fixation ACC.076
 Ground spike Piquet ACC.075	 Snoot tube Casquette tube ACC.106	CV00037 CV00040 CV00041 CV00042 CV00043	 Cable Câble 5m 10m 15m 20m 25m