

 **ULTRA**

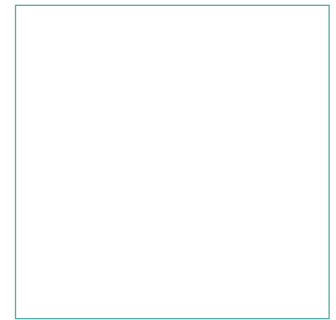

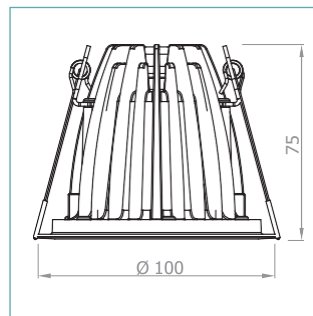

Recessed hole / Foro incasso



Ø88 mm

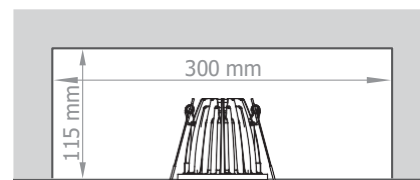

**DESCRIPTION**

Ultra is a professional fixed downlight LED luminaire, with a deep recessed COB LED light source and features high efficiency reflector technology for excellent glare control and uniformity. Ultra offers a choice of three colour temperatures as standard (2700K, 3000K and 4000K) and delivers 90 CRI for excellent colour rendering. With binning-free LEDs carefully selected from two-step MacAdam's ellipses, colour consistency is assured throughout the unonovesette portfolio.

**DESCRIZIONE**

*Ultra è un proiettore professionale a Led da incasso, mediante una posizione molto recessa della sorgente luminosa COB LED. Grazie alla tecnologia a riflettore restituisce un eccellente controllo dell'uniformità e dell'abbagliamento. Ultra offre una scelta fra tre temperature di colore come standard (2700K, 3000K e 4000K) tutte con CRI maggiore di 90 per una eccellente resa cromatica. Binning-free e due-step MacAdam's ellipses LED, assicurano consistenza del colore in tutte le versioni previste da unonovesette.*

**OPTICS / OTTICHE:**

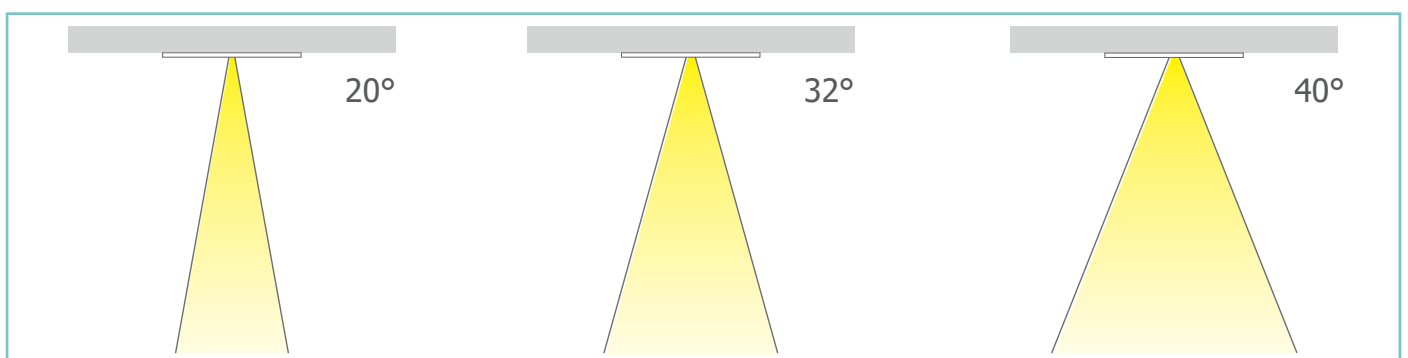



TECHNICAL DATA / SCHEDA PRODOTTO:

<b>Body:</b>	Die-cast aluminium	<b>Corpo:</b>	Pressofusione di alluminio
<b>Glass:</b>	Tempered extra clear glass 4 mm	<b>Vetro:</b>	Vetro temperato extra chiaro 4 mm
<b>Finishes:</b>	White RAL 9003 / Black RAL 9005	<b>Finiture:</b>	Bianco RAL 9003 / Nero RAL 9005
<b>Installation:</b>	Fixing springs	<b>Fissaggio:</b>	Molle di fissaggio
<b>Power supply cables:</b>	35 cm NS20N PCP 2x0,5 mm <sup>2</sup>	<b>Cavo di alimentazione:</b>	35 cm NS20N PCP 2x0,5 mm <sup>2</sup>
<b>Power supply:</b>	Constant current 500mA Max / (350mA-14mA Dim to warm)	<b>Alimentazione:</b>	Constant current 500mA Max / (350mA-14mA Dim to warm)
<b>Power consumption:</b>	12,9 Watt	<b>Potenza assorbita:</b>	12,9 Watt
<b>CRI:</b>	>90	<b>CRI:</b>	>90
<b>Bin selection:</b>	Binning free 2 step MacAdam's	<b>Selezione bin:</b>	Binning free 2 step MacAdam's
<b>Lumenoutput (source):</b>	1154lm (3000K) / 1045lm-28lm (DTW)	<b>Flusso luminoso (sorgente):</b>	1154lm (3000K) / 1045lm-28lm (DTW)
<b>Operating temperature:</b>	-20°C +50°C	<b>Temperatura di funzionamento:</b>	-20°C +50°C
<b>IP rating:</b>	IP65	<b>Grado di protezione:</b>	IP65
<b>Insulation class:</b>	Class III	<b>Classe d'isolamento:</b>	Classe III
<b>Weight:</b>	365 g	<b>Peso:</b>	365 g
<b>Optics:</b>	20° / 32° / 40° / (20° / 40° DTW)	<b>Ottiche:</b>	20° / 32° / 40° / (20° / 40° DTW)
<b>Energy rating:</b>	A++	<b>Energy rating:</b>	A++
<b>LED colour temperature:</b>	2700K / 3000K / 4000K / (3000K-1800K DTW)	<b>Temperatura colore LED:</b>	2700K / 3000K / 4000K / (3000K-1800K DTW)
<b>Lifetime LED:</b>	100000 hrs	<b>Vita media LED:</b>	100000 hrs
<b>Photo biological risk:</b>	RG0 / RG1	<b>Rischio fotobiologico:</b>	RG0 / RG1

FINISHES / FINITURE:

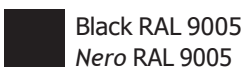

PRODUCT CODE / CODICE PRODOTTO:

LED colour / Colore LED	Optics / Ottiche	Finish/Finiture
<b>27 = 2700K</b> <b>30 = 3000K</b> <b>40 = 4000K</b> <b>DW = Dim to warm</b>	<b>N = 20° (20° DTW)</b> <b>M = 32°</b> <b>W = 40° (40° DTW)</b>	<b>01 = White RAL 9003 / Bianco RAL 9003</b> <b>02 = Black RAL 9005 / Nero RAL 9005</b>

Standard configuration example/  
Esempio di configurazione standard:

**ULT.30.N.01 Ultra 3000K 20° optics white / bianco**



POWER SUPPLIES 500mA CONSTANT CURRENT / ALIMENTATORE CORRENTE COSTANTE 500mA:

On / Off

Code / Codice	Input	I Out	V Out	Watt	IP	#Ultra
PSU.CX.003	110÷240V / 50/60 Hz	500mA	47 V	24	IP20	Max 1
PSU.CX.004	110÷240V / 50/60 Hz	500mA	43 V	20	IP20	Max 1

Dimmable / Dimmerabile

Code / Codice	Input	I Out	V Out	Watt	IP	#Ultra
PSU.CX.001 1-10V/PUSH	100÷240V / 50/60 Hz	500mA	47 V	15	IP20	Max 1
PSU.CX.002 DALI	100÷240V / 50/60 Hz	500mA	47 V	15	IP20	Max 1
PSU.CC.022 DTW DALI	220÷240V / 47/53 Hz	350mA	40 V	20	IP20	Max 1

PHOTOMETRICS / CURVE FOTOMETRICHE:

20° - 12,9 Watt

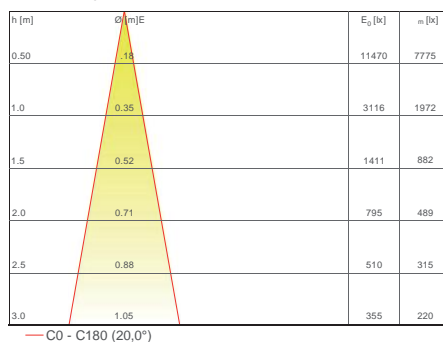

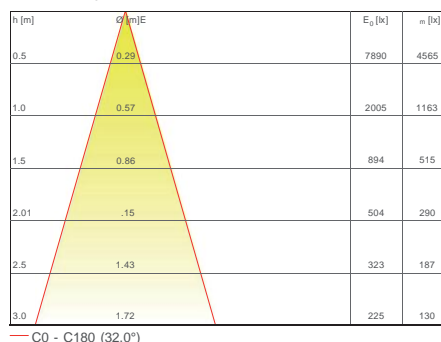

32° - 12,9 Watt

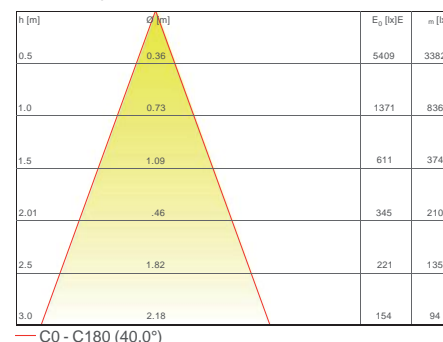

40° - 12,9 Watt



ACCESSORIES / ACCESSORI

 <p>Honeycomb louver Schermo alveolare ACC.001</p>	 <p>Micro prismatic diffuser Filtro diffondente microprismatico ACC.002</p>
---	--