

TRACER 50 Q

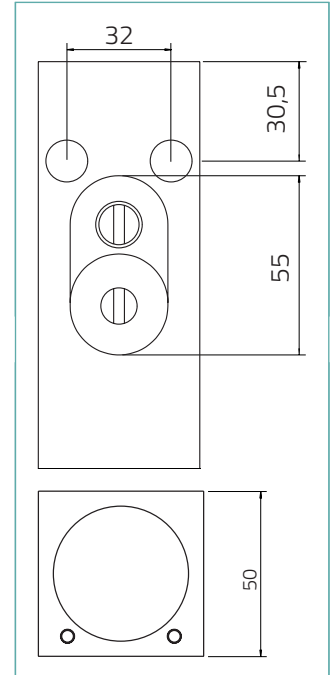
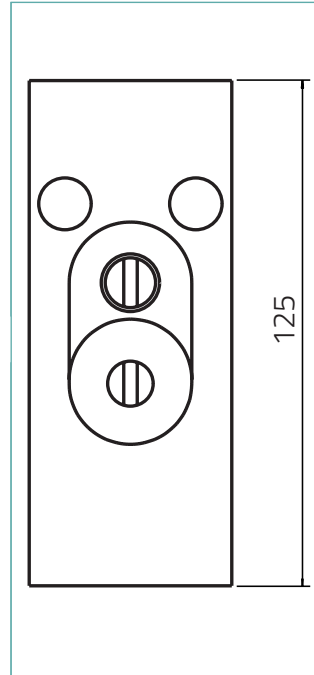

DESCRIPTION

Tracer 50 Q is an extremely efficient compact up and down wall washer, designed for optical excellence and engineered for complete resilience. Tracer 50 Q features the unonovesette Smart Shield system, complete with an integrated constant current driver, which allows the luminaire to be powered in parallel with a 24Vdc constant voltage power supply. With a deep recess of the in-house designed PCB, Tracer 50 Q offers excellent glare control. Available with a choice of three beam angles (10°, 23°, 43°).

DESCRIPTION

Le Tracer 50 Q est un luminaire LED avec dimensions compactes, optique vers le haut et vers le bas extrêmement efficace, conçu avec d'excellentes optiques pour une flexibilité totale. Le Tracer 50 Q intègre le système Smart Shield d'unonovesette, ainsi qu'un circuit en courant constant intégré qui permet d'alimenter le luminaire en parallèle avec une alimentation à tension constante de 24 Vdc. Avec une électronique conçue en interne et bien positionnée, le Tracer 50 Q offre un excellent contrôle de l'éblouissement. Disponible avec un choix de trois optiques (10°, 23°, 43°).

OPTICS / FAISCEAU:

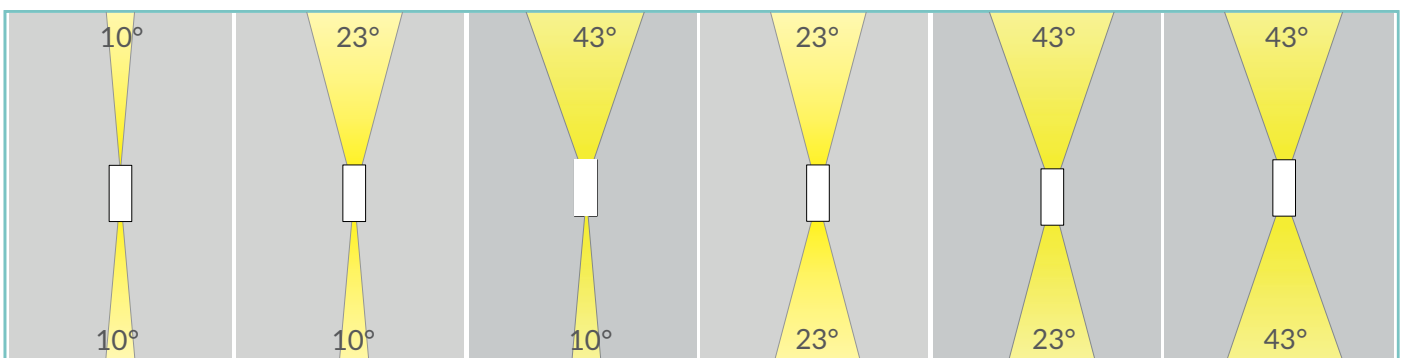



TRACER 50 Q



TECHNICAL SHEET / FICHE PRODUIT:

Body:	Anodized aluminium 6026	Corps:	Anodisé naturel 6026
Glass:	Extra clear tempered glass 2mm	Verre:	Verre temperé extra clair 2 mm
Finishes:	Natural anodized / Black anodized / Flamed bronze	Finitions:	Anodisé naturel / Anodisé Noir / Bronze flammé
Installation:	Surface mounted	Installation:	Surface
Power supply cables:	35 cm NS20N PCP 2x0,5 mm ²	Câbles d'alimentation:	35 cm NS20N PCP 2x0,5 mm ²
Power supply:	Constant voltage 24Vdc	Alimentation:	Tension constante 24Vdc
Power consumption:	4 Watt	Puissance absorbée:	4 Watt
CRI:	>90	IRC Indice de Rendu des Couleurs:	>90
Bin selection:	Binning free 2 step MacAdam's	Sélection du bin:	Binning free 2 step MacAdam's
Lumenoutput (source):	2x140 lm (3000K)	Flux de la source:	2x140 lm (3000K)
Operating temperature:	-20°C +50°C	Température de fonctionnement:	-20°C +50°C
IP rating:	IP66	Indice de protection:	IP66
Insulation class:	Class III	Classe d'isolation:	Classe III
Impact resistance:	IK04	Indice de résistance:	IK04
Weight:	650 g	Poids:	650 g
Optics:	10° / 23° / 43°	Optiques:	10° / 23° / 43°
Energy rating:	A++	Energy rating:	A++
LED colour temperature:	2200K / 2700K / 3000K / 4000K	Couleur LED:	2200K / 2700K / 3000K / 4000K
Lifetime LED:	100000 hrs	Durée moyenne LED:	100000 hrs
Photo biological risk:	RG0 / RG1	Sécurité photobiologique:	RG0 / RG1

FINISHES / FINITIONS:

-  Natural anodized
Anodisé naturel
-  Black anodized
Anodisé noir
-  Flamed bronze
Bronze flammé

PRODUCT CODE/CODE PRODUIT:

T5Q = TRACER 50Q	Select one component from each column to specify a complete configuration: <i>Sélectionner un composant pour chaque colonne pour une configuration complète:</i>			
	LED colour / Couleur LED	Optics / Faisceau	Finish / Finitions	
	22 = 2200K 27 = 2700K 30 = 3000K 40 = 4000K	NN = 10° + 10° NM = 10° + 23° NW = 10° + 43° MM = 23° + 23° MW = 23° + 43° WW = 43° + 43°	05 = Black anodized / <i>Anodisé Noir</i> 07 = Natural anodized / <i>Anodisé naturel</i> 16 = Flamed bronze / <i>Bronze flammé</i>	

Standard configuration example/
Exemple de configuration standard:

T5Q.30.NN.05 Tracer 50 Q 3000K 10° + 10° optics Black anodized / Anodisé Noir

TRACER 50 Q



POWER SUPPLIES 24Vdc CONSTANT VOLTAGE / ALIMENTATEUR TENSION CONSTANTE 24Vdc:

On / Off

QCode / Code	Input	I Out	V Out	Watt	IP	#Tracer 50 Q
PSU.CX.004	110÷240V / 50/60 Hz	0,9 A	24Vdc	20	IP20	Max 4
PSU.CV.005	90÷305V / 47/63 Hz	1 A	24Vdc	25	IP67	Max 5
PSU.CV.006	90÷305V / 47/63 Hz	2,5 A	24Vdc	60	IP67	Max 12
PSU.CV.007	90÷305V / 47/63 Hz	3,75 A	24Vdc	90	IP67	Max 18

Control gear / Système de control

Code / Code	Input	I Out	V Out	Watt	IP	#Tracer 50 Q
CGE.004 - 0/1-10V	24Vdc	6,5 A	24Vdc	156	IP20	Max 35
CGE.017 - DALI	24Vdc	6,5 A	24Vdc	156	IP20	Max 35
CGE.017.IP - DALI	24Vdc	6,5 A	24Vdc	156	IP67	Max 35
CGE.020 - DMX	24Vdc	6,5 A	24Vdc	156	IP20	Max 35

PHOTOMETRICS / COURVES PHOTOMETRIQUE:

10° - 4 Watt

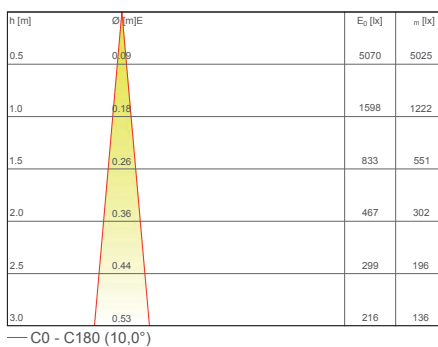

23° - 4 Watt

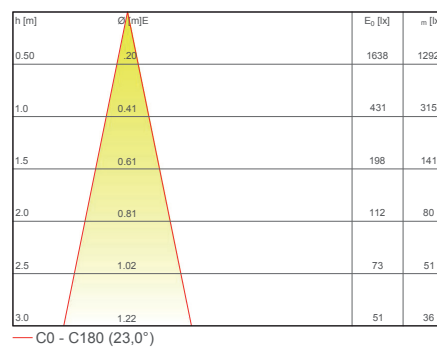

43° - 4 Watt

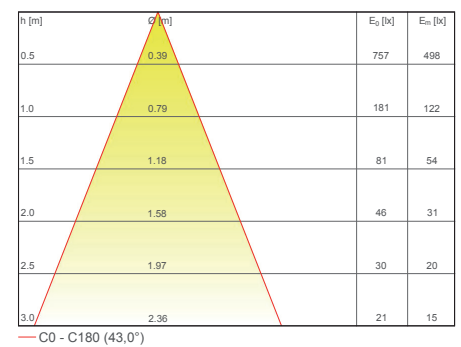

ACCESSORIES / ACCESSOIRES



Honeycomb louver
Grille nid d'abeille
ACC.084