

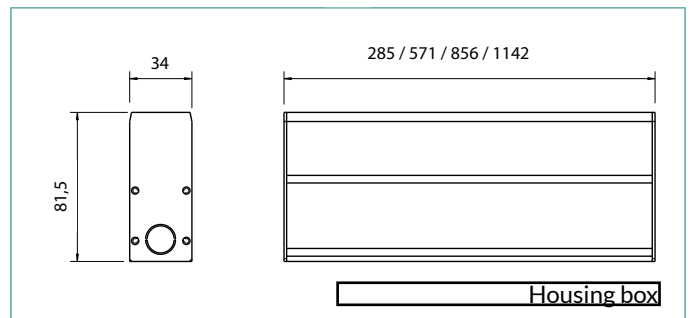

SLASH 30

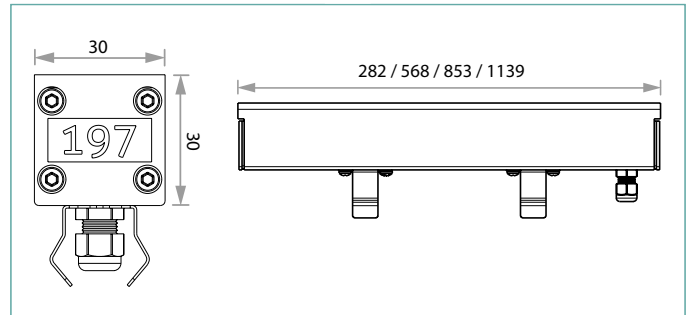

DESCRIPTION

Slash 30 is made of extruded high quality anticorodal hard anodised aluminium and is designed for outdoor in-ground or surface mounted applications. It is available with 4 different optics including wall washing and wall grazing. The Slash 30 offers 2200K, 2700K, 3000K and 4000K as standard colour temperatures as well as RGBW and Tunable white. Glare control is further enhanced by the unique linear anti-glare louvre, which is especially designed for wall washing and grazing applications providing exceptional uniformity. A housing box is available for convenient and a continuous ground installation and adjustable brackets are available for a surface mounted installation.

DESCRIPTION

Slash 30 est fabriqué en aluminium extrudé anticorodal, anodisé dur, de haute qualité. Il est conçu pour les applications extérieures encastrées ou en surface. Il est disponible dans 4 optiques différentes dont wall washing et wall grazing. Le Slash 30 est disponible dans les températures standard, 2200K, 2700K, 3000K et 4000K, ainsi qu'en RGBW et Tunable white. Le contrôle de l'éblouissement est encore renforcé par la grille anti-éblouissement linéaire unique, spécialement conçue pour les applications wall washing et wall grazing, offrant une uniformité exceptionnelle.

OPTICS / FAISCEAU:

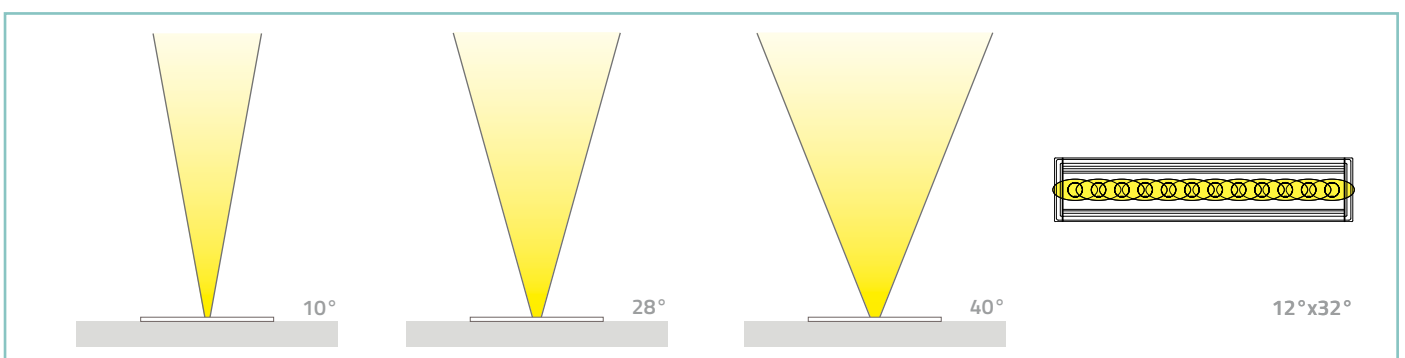



SLASH 30



TECHNICAL DATA / SCHEDE APPRODOTTE:

Body:	Extruded aluminium	Corps:	Aluminium extrudé
Glass:	Extra clear tempered 4 mm	Verre:	Extra clair trempé 4 mm
Finishes:	Natural anodized	Finitions:	Anodisé naturel
Installation:	Housing box / Fixing brackets	Installation:	Boîtier d'encastrement / Étriers de fixation
Power supply cables:	IP68 30Cm with Easy-Lock connector	Câbles d'alimentation:	IP68 30Cm avec connecteur Easy-Lock
Power supply:	Constant voltage 24Vdc	Alimentation:	Tension constante 24Vdc
Power consumption P5 1W:	6,4 W / 12,8 W / 19,2 W / 25,6 W	Puissance absorbée P5 1W:	6,4 W / 12,8 W / 19,2 W / 25,6 W
Lumenoutput P5 1W (source):	630 / 1260 / 1890 / 2520 lm (3000K)	Flux de la source P5 1W:	630 / 1260 / 1890 / 2520 lm (3000K)
Power consumption P5 2W:	13,4 W / 26,8 W / 40,2 W / 53,6 W	Puissance absorbée P5 2W:	13,4 W / 26,8 W / 40,2 W / 53,6 W
Lumenoutput P5 2W (source):	1140 / 2280 / 3420 / 4560 lm (3000K)	Flux de la source P5 2W:	1140 / 2280 / 3420 / 4560 lm (3000K)
Power consumption P10 1W:	3,5 W / 7 W / 10,5 W / 14 W	Puissance absorbée P10 1W:	3,5 W / 7 W / 10,5 W / 14 W
Lumenoutput P10 1W (source):	315 / 630 / 945 / 1260 lm (3000K)	Flux de la source P10 1W:	315 / 630 / 945 / 1260 lm (3000K)
Power consumption P10 2W:	7,1 W / 14,2 W / 21,3 W / 28,4 W	Puissance absorbée P10 2W:	7,1 W / 14,2 W / 21,3 W / 28,4 W
Lumenoutput P10 2W (source):	570 / 1140 / 1170 / 2280 lm (3000K)	Flux de la source P10 2W:	570 / 1140 / 1170 / 2280 lm (3000K)
Power consumption RGBW / TW:	11,6 W / 23,1 W / 34,7 W / 43,5 W	Puissance absorbée RGBW / TW:	11,6 W / 23,1 W / 34,7 W / 43,5 W
CRI:	> 90	IRC Indice de Rendu des Couleurs:	> 90
Bin selection:	Binning free 2 step MacAdam's	Sélection du bin:	Binning free 2 step MacAdam's
Operating temperature:	-20°C +50°C	Température de fonctionnement:	-20°C +50°C
IP rating:	IP67	Indice de protection:	IP67
Insulation class:	Class III	Classe d'isolation:	Classe III
Impact resistance:	IK06	Indice de résistance:	IK06
Weight:	460 g / 880 g / 1,3 kg / 1,72 kg	Poids:	460 g / 880 g / 1,3 kg / 1,72 kg
Optics:	12° / 21° / 31° / 46° / 36°x13° 10° / 23° / 34° (RGBW - TW)	Optiques:	12° / 21° / 31° / 46° / 36°x13° 10° / 23° / 34° (RGBW - TW)
LED colour temperature:	2200K / 2700K / 3000K / 4000K / RGBW / TW	Couleur LED:	2200K / 2700K / 3000K / 4000K / RGBW / TW
Lifetime LED:	100000 hrs	Durée moyenne LED:	100000 hrs
Photo biological risk:	RG0 / RG1	Sécurité photobiologique:	RG0 / RG1

FINISHES / FINITIONS:

 Natural anodized
Anodisé naturel

SLASH 30



PHOTOMETRICS / COURVES PHOTOMETRIQUE:

12°- P05 - 13,4W

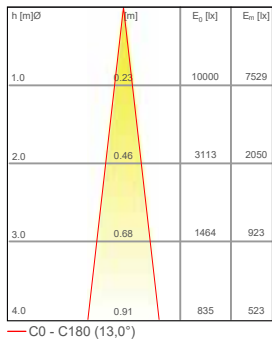

21°- P05 - 13,4W

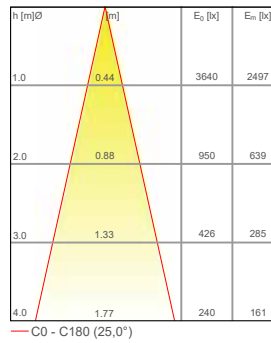

31°- P05 - 13,4W

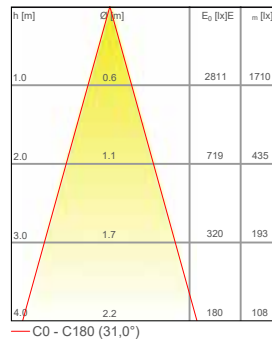

46°- P05 - 13,4W

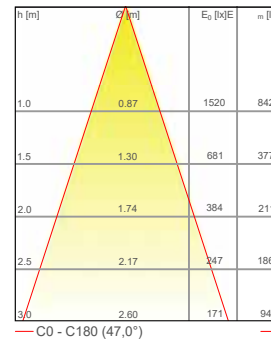

36° x 13°- P05 - 13,4W

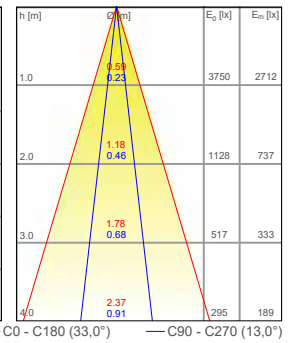

PRODUCT CODE/CODE PRODUIT:

SLA30P5 = SLASH 30 P5



Select one component from each column to specify a complete configuration:
Sélectionner un composant pour chaque colonne pour une configuration complète:

LED colour / Couleur LED	Optics / Faisceau	Finish / Finitions	Length/ Longueur - Power / Puissance
22 = 2200K 27 = 2700K 30 = 3000K 40 = 4000K	N = 12° M = 21° W = 31° F = 46° E = 36°x13°	07 = Natural anodized / Anodisé naturel	0282 = 282 mm - 06 = 6,4 W / 13 = 13,4 W 0568 = 568 mm - 12 = 12,8 W / 26 = 26,8 W 0853 = 853 mm - 20 = 19,2 W / 40 = 40,2 W 1139 = 1139 mm - 26 = 25,6 W / 53 = 53,6 W

Standard configuration example/
Exemple de configuration standard: **SLA30P5.30.M.07.0568** Slash 30 P5 3000K 21°optics Natural anodized / Anodisé naturel 568mm

SLA30P10 = SLASH 30 P10



Select one component from each column to specify a complete configuration:
Sélectionner un composant pour chaque colonne pour une configuration complète:

LED colour / Couleur LED	Optics / Faisceau	Finish / Finitions	Length/ Longueur - Power / Puissance
22 = 2200K 27 = 2700K 30 = 3000K 40 = 4000K	N = 12° M = 21° W = 31° F = 46° E = 36°x13°	07 = Natural anodized / Anodisé naturel	0282 = 282 mm - 03 = 3,5 W / 07 = 7,1 W 0568 = 568 mm - 07 = 7 W / 14 = 14,2 W 0853 = 853 mm - 10 = 10,5 W / 21 = 21,3 W 1139 = 1139 mm - 14 = 14 W / 28 = 28,4 W

Standard configuration example/
Exemple de configuration standard: **SLA30P10.30.M.07.0568** Slash 30 P10 3000K 21°optics Natural anodized / Anodisé naturel 568mm

SLA30 = SLASH 30 RGBW



Select one component from each column to specify a complete configuration:
Sélectionner un composant pour chaque colonne pour une configuration complète:

LED colour / Couleur LED	Optics / Faisceau	Finish / Finitions	Length/ Longueur - Power / Puissance
FC = RGBW	N = 10° M = 23° W = 34°	07 = Natural anodized / Anodisé naturel	0282 = 282 mm - 14 = 14 W 0568 = 568 mm - 28 = 28 W 0853 = 853 mm - 42 = 42 W 1139 = 1139 mm - 56 = 56 W

Standard configuration example/
Exemple de configuration standard: **SLA30.FC.M.07.0568** Slash 30 RGBW 3000K 23°optics Natural anodized / Anodisé naturel 568mm

SLA30 = SLASH 30 TW



Select one component from each column to specify a complete configuration:
Sélectionner un composant pour chaque colonne pour une configuration complète:

LED colour / Couleur LED	Optics / Faisceau	Finish / Finitions	Length/ Longueur - Power / Puissance
TW = Tunable white	N = 10° M = 23° W = 34°	07 = Natural anodized / Anodisé naturel	0282 = 282 mm - 14 = 14 W 0568 = 568 mm - 28 = 28 W 0853 = 853 mm - 42 = 42 W 1139 = 1139 mm - 56 = 56 W

Standard configuration example/
Exemple de configuration standard: **SLA30.TW.M.07.0568** Slash 30 TW 3000K 23°optics Natural anodized / Anodisé naturel 568mm

SLASH 30



POWER SUPPLIES 24Vdc CONSTANT VOLTAGE / ALIMENTATEUR TENSION CONSTANTE 24Vdc:

On / Off

Code / Code	Input	I Out	V Out	Watt	IP
PSU.CX.004	110÷240V / 50/60 Hz	0,9 A	24Vdc	20	IP20
PSU.CV.005	90÷305V / 47/63 Hz	1 A	24Vdc	25	IP67
PSU.CV.006	90÷305V / 47/63 Hz	2,5 A	24Vdc	60	IP67
PSU.CV.007	90÷305V / 47/63 Hz	3,75 A	24Vdc	90	IP67
PSU.CV.021	90÷305V / 47/63 Hz	10 A	24Vdc	240	IP 67

Control gear / Système de control Slash 30 P5 1143mm 53,6 W

Code / Code	Input	I Out	V Out	Watt	IP	#Slash 30
CGE.004 - 0/1-10V	24Vdc	6,5 A	24Vdc	156	IP20	Max 2
CGE.017 - DALI	24Vdc	6,5 A	24Vdc	156	IP20	Max 2
CGE.017.IP - DALI	24Vdc	6,5 A	24Vdc	156	IP67	Max 2
CGE.020 - DMX	24Vdc	6,5 A	24Vdc	156	IP20	Max 2







Control gear / Système de control Slash 30 P10 1143mm 28,4 W

Code / Code	Input	I Out	V Out	Watt	IP	#Slash 30
CGE.004 - 0/1-10V	24Vdc	6,5 A	24Vdc	156	IP20	Max 5
CGE.017 - DALI	24Vdc	6,5 A	24Vdc	156	IP20	Max 5
CGE.017.IP - DALI	24Vdc	6,5 A	24Vdc	156	IP67	Max 5
CGE.020 - DMX	24Vdc	6,5 A	24Vdc	156	IP20	Max 5

Control gear / Système de control RGBW / TW 1143mm 56 W

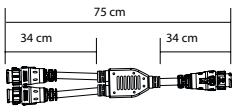
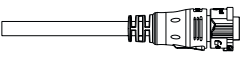
Code / Code	Input	I Out	V Out	Watt	IP	#Slash 30
CGE.016 - DALI RGBW / TW	24Vdc	4x5 A	24Vdc	480	IP20	Max 8 m
CGE.019 - DMX RGBW / TW	24Vdc	4x5 A	24Vdc	480	IP20	Max 8 m

ACCESSORIES / ACCESSOIRES

 <p>HB.010.0285 (0,35kg) HB.010.0571 (0,70 kg) HB.010.0856 (0,96 kg) HB.010.1142 (1,38 kg)</p> <p>Housing box Boîtier d'encastrement</p>	 <p>ACC.130.0268 ACC.130.0554 Anti-Glare louver ACC.130.0840 Grille ACC.130.1126 anti-éblouissement</p>	 <p>Fixing bracket Étriers de fixation ACC.125</p>	 <p>Y connection cable Câble de connexion Y ACC.058</p>	
 <p>Head Cable 5m Câble de tête 5 mètres ACC.057</p>	 <p>Extension cable 1m Rallonge 1 m ACC.059</p>	 <p>Extension cable 2m Rallonge 2 m ACC.131</p>	 <p>Housing box alignment kit Kit de fixation ACC.093</p>	 <p>Housing box fixing kit Kit de fixation ACC.094</p>