

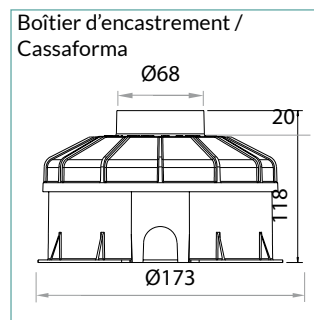

CALIBER 80 SUB

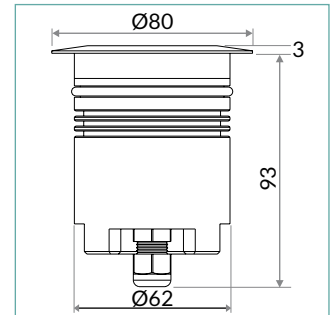
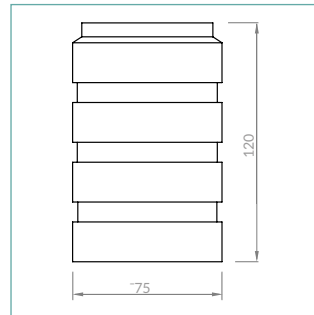

DESCRIPTION

Caliber 80 sub is an extremely efficient compact underwater recessed LED projector, designed for optical excellence and engineered for complete resilience. Caliber 80 sub offers a choice of four colour temperatures as standard (2700K, 3000K and 4000K) and delivers 90 CRI for excellent colour rendering, and with binning-free LEDs carefully selected from two-step MacAdam's ellipses, colour consistency is assured throughout the unonovesette portfolio. With a deep recess of the in-house designed PCB, Caliber 80 sub offers excellent glare control.

DESCRIPTION

Le Caliber 80 sub est un luminaire à LED compact, pour l'immersion jusqu'à 5 mètres de profondeur et très efficace. Il est conçu avec d'excellentes optiques et pour une flexibilité complète. Le Caliber 80 sub donne un choix de 4 températures de couleur 2200/2700/3000/4000K avec IRC > 90 pour une excellente constance chromatique. Binning-free et 2 step MacAdam garantissent la cohérence des couleurs dans toutes les versions fournies par unonovesette. Avec une électronique conçue en interne et bien positionnée, le Caliber 80 sub offre un excellent contrôle de l'éblouissement.

OPTICS / FAISCEAU:

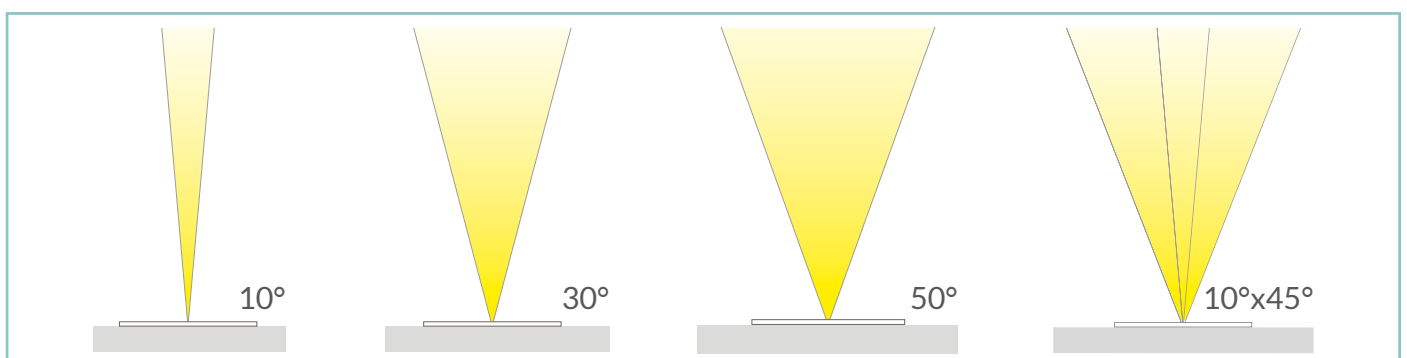



CALIBER 80 SUB



TECHNICAL SHEET / FICHE PRODUIT:

Body:	Stainless Steel AISI316L	Corps:	Acier INOX AISI316L
Glass:	Tempered extra clear / frosted 8 mm	Verre:	Verre temperé extra clair / satiné 8 mm
Finishes:	Stainless Steel AISI316L	Finitions:	Acier INOX AISI316L
Installation:	Housing box	Installation:	Boîtier d'encastrement
Power supply cables:	500 cm NS20N PCP 2x0,5 mm ²	Câbles d'alimentation:	500 cm NS20N PCP 2x0,5 mm ²
Power supply:	Constant voltage 24Vdc	Alimentation:	Tension constante 24Vdc
Power consumption:	5 Watt / 9 Watt	Puissance absorbée:	5 Watt / 9 Watt
CRI:	>90	IRC Indice de Rendu des Couleurs:	>90
Bin selection:	Binning free 2 step MacAdam's	Sélection du bin:	Binning free 2 step MacAdam's
Lumen Output:	515 lm / 730 lm (3000K)	Flux lumineux:	515 lm / 730 lm (3000K)
Operating temperature:	-20°C +50°C	Température de fonctionnement:	-20°C +50°C
IP rating:	IP68 (5 meter underwater)	Indice de protection:	IP68 (5 mètres sous l'eau)
Insulation class:	Class III	Classe d'isolation:	Classe III
Impact resistance:	IK08	Indice de résistance:	IK08
Weight:	570 g	Poids:	570 g
Optics:	10° / 30° / 50° / 10°x 45° / (35° RGBW) / Satin	Optiques:	10° / 30° / 50° / 10°x 45° / (35° RGBW) / Satiné
LED colour temperature:	2700K / 3000K / 4000K / RGBW	Couleur LED:	2700K / 3000K / 4000K / RGBW
Lifetime LED:	100000 hrs	Durée moyenne LED:	100000 hrs
Photo biological risk:	RG0 / RG1	Sécurité photobiologique:	RG0 / RG1

FINISHES / FINITIONS:

	Stainless steel AISI316L Acier INOX AISI316L
--	---

PRODUCT CODE/CODE PRODUIT:

C80 = CALIBER 80	Select one component from each column to specify a complete configuration: Sélectionner un composant pour chaque colonne pour une configuration complète:			
	LED colour / Couleur LED	Optics / Faisceau	Finish / Finitions	Watt
	27 = 2700K 30 = 3000K 40 = 4000K FC = RGBW	N = 10° M = 30° (35° RGBW) W = 50° E = 10°x 45° S = Satin/Satiné	03 = Stainless steel AISI316L / Acier INOX AISI316L	05 = 5W 09 = 9W

Standard configuration example / Exemple de configuration standard: **C80.30.N.03.09** Caliber 80 3000K 10° optics stainless steel / Acier INOX 9 Watt



CALIBER 80 SUB



POWER SUPPLIES 24Vdc CONSTANT VOLTAGE / ALIMENTATEUR TENSION CONSTANTE 24Vdc:

On / Off

Code / Code	Input	I Out	V Out	Watt	IP	#Caliber 80
PSU.CX.004	110÷240V / 50/60 Hz	0,9 A	24Vdc	20	IP20	Max 2
PSU.CV.005	90÷305V / 47/63 Hz	1 A	24Vdc	25	IP67	Max 2
PSU.CV.006	90÷305V / 47/63 Hz	2,5 A	24Vdc	60	IP67	Max 6
PSU.CV.007	90÷305V / 47/63 Hz	3,75 A	24Vdc	90	IP67	Max 8

Control gear / Système de control

Code / Code	Input	I Out	V Out	Watt	IP	#Caliber 80
CGE.004 - 0/1-10V	24Vdc	6,5 A	24Vdc	156	IP20	Max 15
CGE.017 - DALI	24Vdc	6,5 A	24Vdc	156	IP20	Max 15
CGE.017.IP - DALI	24Vdc	6,5 A	24Vdc	156	IP67	Max 15
CGE.020 - DMX	24Vdc	6,5 A	24Vdc	156	IP20	Max 15

PHOTOMETRICS / COURVES PHOTOMETRIQUE:

10° - 9 Watt

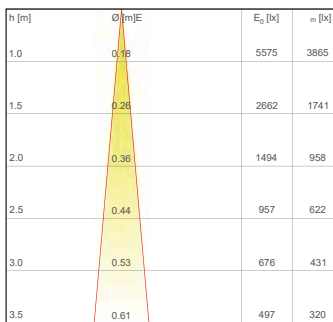

— C0 - C180 (10,0°)

30° - 9 Watt

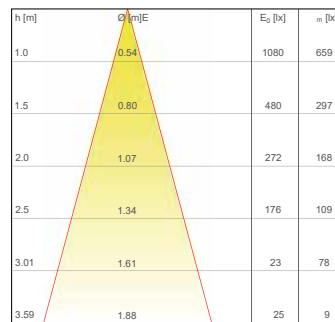

— C0 - C180 (30,0°)

50° - 9 Watt

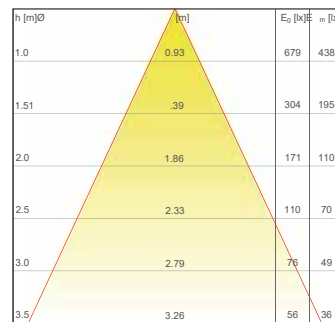



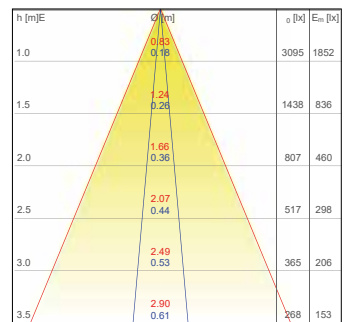

— C0 - C180 (50,0°)

10°x45° - 9 Watt



— C0 - C180 (45,0°) — C90 - C270 (10,0°)

ACCESSORIES / ACCESSOIRES

 <p>Housing Box Boîtier d'encastrement HB.003 (170 g)</p>	 <p>Housing Box Boîtier d'encastrement HB.014 (170 g)</p>	 <p>Honeycomb louver Grille nid d'abeille ACC.004</p>	 <p>Anti-Glare louver Visière anti-éblouissement ACC.073</p>	 <p>Cable Câble CV00040 10m CV00041 15m CV00042 20m CV00043 25m</p>
--	--	--	--	--