

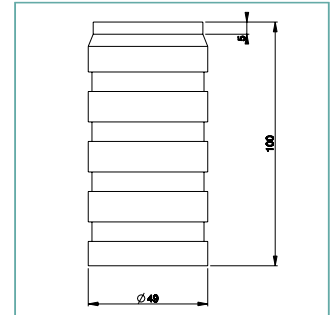

CALIBER 55 SUB

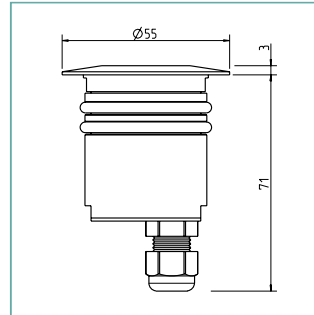

Recessed hole / Trou d'encastrement:



DESCRIPTION

Caliber 55 sub is an extremely efficient compact underwater recessed LED projector, designed for optical excellence and engineered for complete resilience. Caliber 55 sub offers a choice of four colour temperatures as standard (2200K, 2700K, 3000K and 4000K) and delivers 90 CRI for excellent colour rendering, and with binning-free LEDs carefully selected from two-step MacAdam's ellipses, colour consistency is assured throughout the unonovesette portfolio. With a deep recess of the in-house designed PCB, Caliber 55 sub offers excellent glare control.

DESCRIPTION

Le Caliber 55 sub est un luminaire à LED compact, pour l'immersion jusqu'à 5 mètres de profondeur et très efficace. Il est conçu avec d'excellentes optiques et pour une flexibilité complète. Le Caliber 55 sub donne un choix de 4 températures de couleur 2200/2700/3000/4000K avec IRC >90 pour une excellente constance chromatique. Binning-free et 2 step MacAdam garantissent la cohérence des couleurs dans toutes les versions fournies par unonovesette. Avec une électronique conçue en interne et bien positionnée, le Caliber 55 sub offre un excellent contrôle de l'éblouissement.

OPTICS / FAISCEAU:

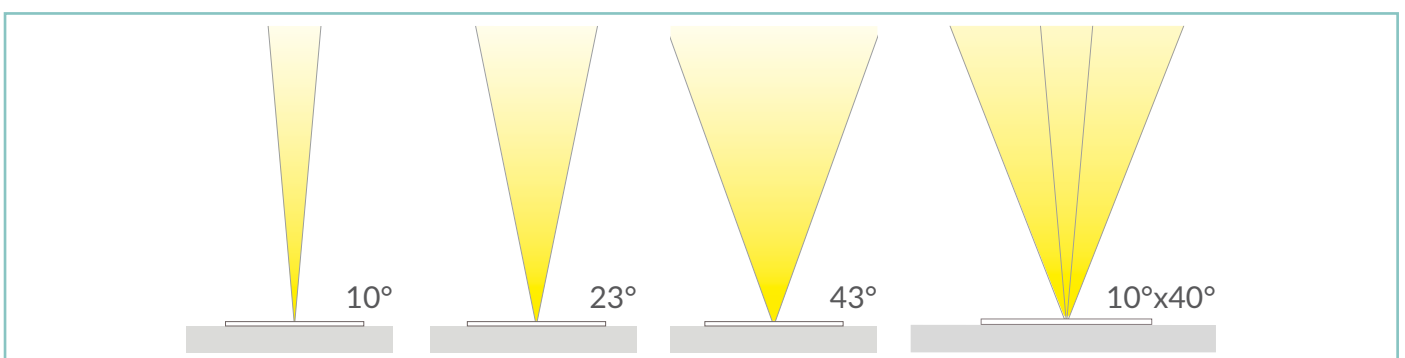



CALIBER 55 SUB



TECHNICAL SHEET / FICHE PRODUIT:

Body:	Machined, electropolished stainless steel AISI316L	Corps:	Acier inoxydable AISI316L électropoli
Glass:	Extra clear 4mm tempered glass	Verre:	Verre temperé extra clair 4 mm
Finishes:	Electropolished stainless steel AISI316L	Finitions:	Acier inoxydable électropoli AISI316L
Installation:	Housing box	Installation:	Boîtier d'encastrement
Power supply cables:	500cm NS20N PCP 2x0,5 mm ²	Câbles d'alimentation:	500cm NS20N PCP 2x0,5 mm ²
Power supply:	Constant voltage 24Vdc	Alimentation:	Tension constante 24Vdc
Power consumption:	2 Watt	Puissance absorbée:	2 Watt
CRI:	>90	IRC Indice de Rendu des Couleurs:	>90
Bin selection:	Binning free 2 step MacAdam's	Sélection du bin:	Binning free 2 step MacAdam's
Lumenoutput (source):	140 lm (3000K)	Flux de la source:	140 lm (3000K)
Operating temperature:	-20°C +50°C	Température de fonctionnement:	-20°C +50°C
IP rating:	IP68 (5 meter underwater)	Indice de protection:	IP68 (5 mètres sous l'eau)
Insulation class:	Class III	Classe d'isolation:	Classe III
Impact resistance:	IK08	Indice de résistance:	IK08
Weight:	600 g	Poids:	600 g
Optics:	10° / 23° / 43° / 10°X40°	Optiques:	10° / 23° / 43° / 10°X40°
Energy rating:	A++	Classe d'efficacité énergétique:	A++
LED colour temperature:	2200K / 2700K / 3000K / 4000K	Couleur LED:	2200K / 2700K / 3000K / 4000K
Lifetime LED:	100000 hrs	Durée moyenne LED:	100000 hrs
Photo biological risk:	RG0 / RG1	Sécurité photobiologique:	RG0 / RG1

FINISHES / FINITIONS:

 Stainless steel electropolished AISI316L
Acier INOX électropoli AISI316L

PRODUCT CODE/CODE PRODUIT:

<p>C55 = CALIBER 55 SUB</p> 	Select one component from each column to specify a complete configuration: Sélectionner un composant pour chaque colonne pour une configuration complète:			
	LED colour / Couleur LED	Optics / Faisceau	Finish / Finitions	
22 = 2200K 27 = 2700K 30 = 3000K 40 = 4000K	N = 10° M = 23° W = 43° E = 10°x40°	12 = Stainless steel electropolished AISI316L / Acciaio INOX électropoli AISI316L		

Standard configuration example/
Exemple de configuration standard:

C55.30.N.12 Caliber 55 SUB 3000K 10° optics stainless steel / Acier INOX



CALIBER 55 SUB



POWER SUPPLIES 24Vdc CONSTANT VOLTAGE / ALIMENTATEUR TENSION CONSTANTE 24Vdc:

On / Off

Code / Code	Input	I Out	V Out	Watt	IP	#Caliber 55 sub
PSU.CX.004	110÷240V / 50/60 Hz	0,9 A	24Vdc	20	IP20	Max 8
PSU.CV.005	90÷305V / 47/63 Hz	1 A	24Vdc	25	IP67	Max 10
PSU.CV.006	90÷305V / 47/63 Hz	2,5 A	24Vdc	60	IP67	Max 25
PSU.CV.007	90÷305V / 47/63 Hz	3,75 A	24Vdc	90	IP67	Max 36

Control gear / Système de control

Code / Code	Input	I Out	V Out	Watt	IP	#Caliber 55 sub
CGE.004 - 0/1-10V	24Vdc	6,5 A	24Vdc	156	IP20	Max 70
CGE.017 - DALI	24Vdc	6,5 A	24Vdc	156	IP20	Max 70
CGE.017.IP - DALI	24Vdc	6,5 A	24Vdc	156	IP67	Max 70
CGE.020 - DMX	24Vdc	6,5 A	24Vdc	156	IP20	Max 70

PHOTOMETRICS / COURVES PHOTOMETRIQUE:

10° - 2 Watt

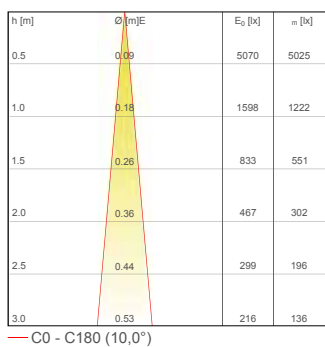

23° - 2 Watt

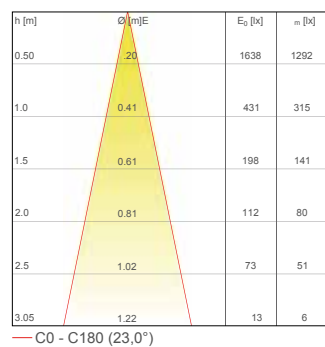



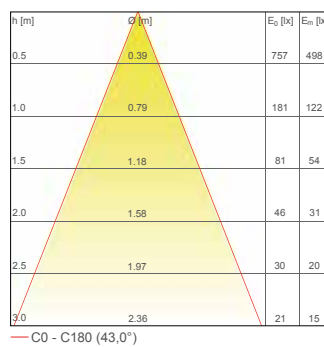

43° - 2 Watt

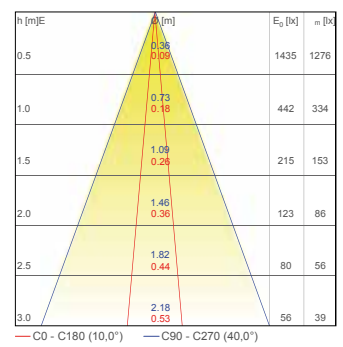

10°x40° - 2 Watt



ACCESSORIES / ACCESSOIRES

 <p>Housing Box Boîtier d'encastrement HB.009 (70 g)</p>	 <p>Honeycomb louver Grille nid d'abeille ACC.084</p>	 <p>Anti-Glare louver Visière anti-éblouissement ACC.008</p>	 <p>Cable Câble</p> <table border="0"> <tr> <td>CV00040</td> <td>10m</td> </tr> <tr> <td>CV00041</td> <td>15m</td> </tr> <tr> <td>CV00042</td> <td>20m</td> </tr> <tr> <td>CV00043</td> <td>25m</td> </tr> </table>	CV00040	10m	CV00041	15m	CV00042	20m	CV00043	25m
CV00040	10m										
CV00041	15m										
CV00042	20m										
CV00043	25m										