



ZENDRA

OPERATING INSTRUCTIONS
 ISTRUZIONI D'USO
 INSTRUCTIONS POUR L'UTILISATION
 GEBRAUCHSANWEISUNG



IP20

MADE IN ITALY



Product for indoor applications.
Prodotto per uso interno.
 Produit pour applications intérieures.
 Produkt für Innenanwendungen.



Read and retain the instructions.
Leggere e conservare le istruzioni.
 Lisez et conservez ces instructions.
 Lesen und bewahren Sie die Anweisungen auf.

Powersupply	Constant current
Alimentazione	350mA Max /
Alimentation	350mA-14mA
Stromversorgung	Dim to Warm

Max. power consumption	
Max. potenza assorbita	12,9W
Max. puissance	
Max. Stromverbrauch	

Insulation Class	
Classe di isolamento	
Classe d'isolation	
Schutzklasse	

Max. weight	
Max. peso	610g
Max. poids	
Max. Gewicht	

1

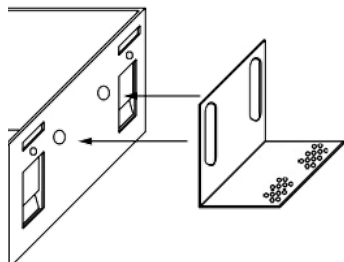

2

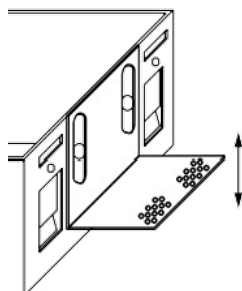

3

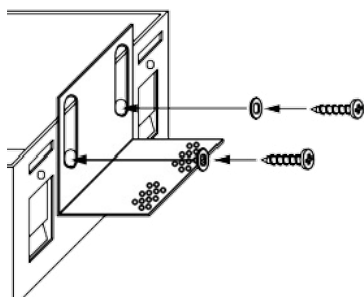

4

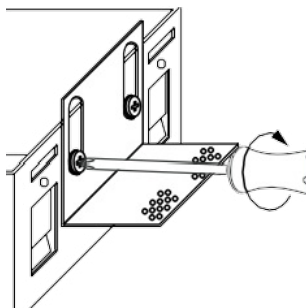

1

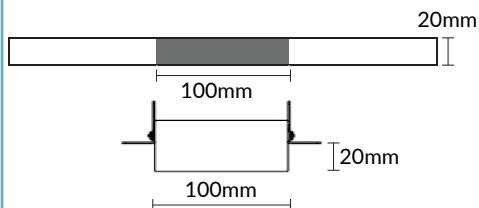

2

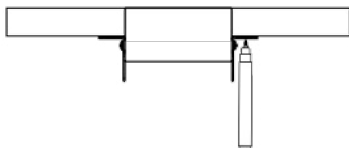

3

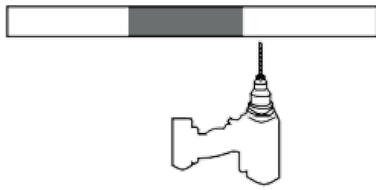

4

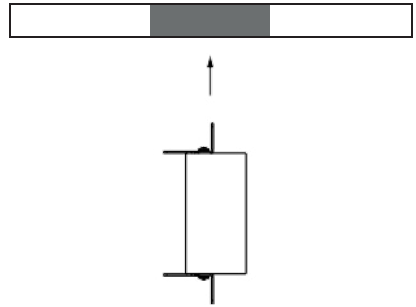

5

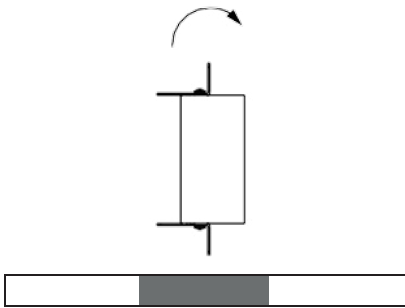

6

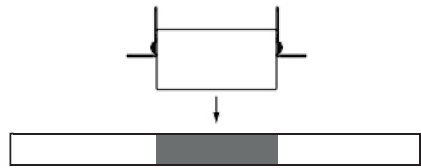

7

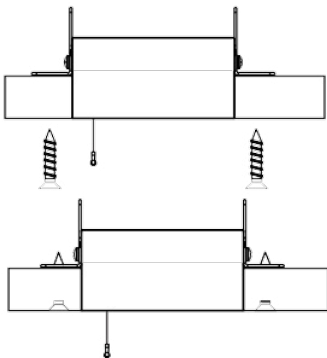

8

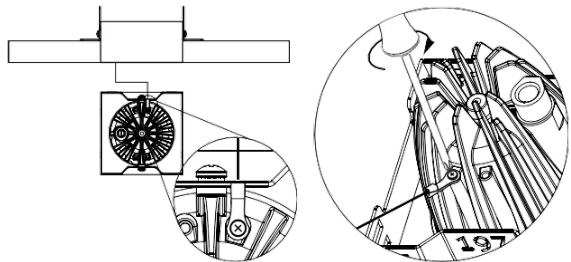

9

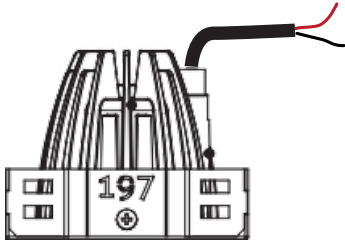

	UE	US
+	Red	White
-	Black	Black

10

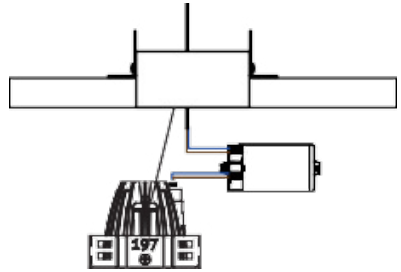

11

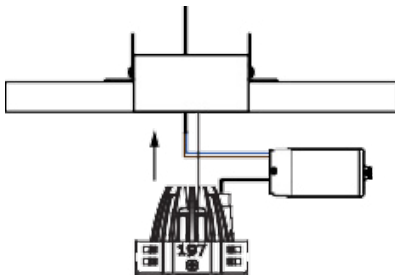

12



ON / OFF

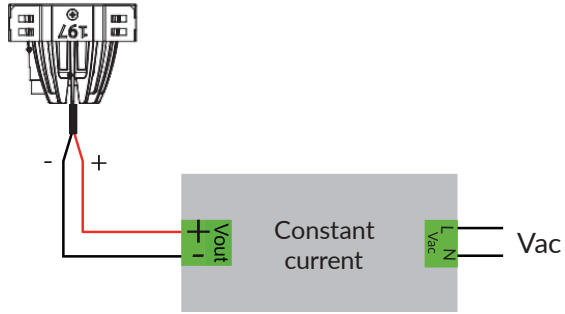

DIMMER-DALI

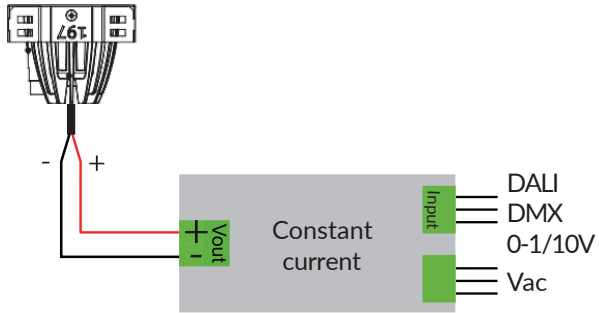

DIM TO WARM

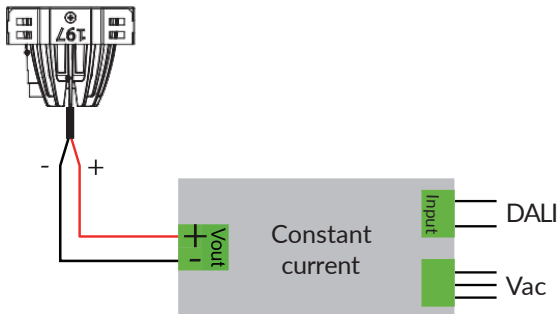

WARNING!



Do not cover the fixture, make sure that the correct cooling of the lamp is guaranteed.

When connecting and disconnecting the device, make sure that the power supply is not powered.

The safety of the appliance is guaranteed by observance of these instructions, therefore it is recommended to keep them.

All assembly, maintenance and replacement operations on the appliance must be carried out making sure that the power is off.

The installation must be carried out by qualified installers in full compliance with the legislation.

ATTENZIONE!

Non coprire l'apparecchio, assicurarsi che sia garantito il corretto raffreddamento della lampada.

Durante la connessione e la disconnessione dell'apparecchio assicurarsi che l'alimentatore non sia alimentato.

La sicurezza dell'apparecchio é garantita dall'osservanza di queste istruzioni pertanto si raccomanda di conservarle.

Tutte le operazioni di montaggio, manutenzione e sostituzione dell'apparecchio vanno eseguite assicurandosi che la rete di alimentazione sia disinserita.

L'installazione deve essere effettuata da installatori qualificati nel pieno rispetto della normativa.

ATTENTION!

Ne couvrez pas le luminaire, assurez-vous que le refroidissement correct de la lampe est garanti.

Lors de la connexion et de la déconnexion de l'appareil, assurez-vous que l'alimentation n'est pas alimentée.

La sécurité de l'appareil est garantie par le respect de ces instructions, il est donc recommandé de les conserver.

Toutes les opérations de montage, d'entretien et de remplacement de l'appareil doivent être effectuées en s'assurant que l'alimentation est coupée.

L'installation doit être effectuée par des installateurs qualifiés en pleine conformité avec la législation.

WARNUNG!

Decken Sie die Leuchte nicht ab, stellen Sie sicher, dass die richtige Kühlung der Lampe gewährleistet ist.

Stellen Sie beim Anschließen und Trennen des Geräts sicher, dass die Stromversorgung spannungslos ist.

Die Sicherheit des Gerätes wird durch die Beachtung dieser Anleitung gewährleistet, daher wird empfohlen, sie aufzubewahren.

Bei allen Montage-, Wartungs- und Austauscharbeiten am Gerät muss sichergestellt sein, dass die Stromversorgung unterbrochen ist.

Die Installation muss von qualifizierten Installateuren unter vollständiger Einhaltung der Gesetzgebung durchgeführt werden.

NOTE / NOTA / REMARQUE / NOTIZ



Use only constant voltage power supplies supplied by unonovesette, the use of different power supplies will void the warranty.

Utilizzare esclusivamente alimentatori a tensione costante forniti da unonovesette, l'utilizzo di alimentatori differenti invalida la garanzia.

Utilisez uniquement des alimentations à tension constante fournies par unonovesette, l'utilisation d'alimentations différentes annulera la garantie.

Verwenden Sie nur Konstantspannungsnetzteile von unonovesette, bei Verwendung anderer Netzteile erlischt die Garantie.

unonovesette

Via Galileo Galilei, 15
20856 Correzzana (MB) Italy
(+39) 039 6367340

info@unonovesette.it
www.unonovesette.it