



STELVIO 66

SCHEDA TECNICA

INFORMAZIONI SUL PROGETTO

Nome progetto:

Riferimento:

Quantità:



IP67

MADE IN ITALY

DISEGNO TECNICO

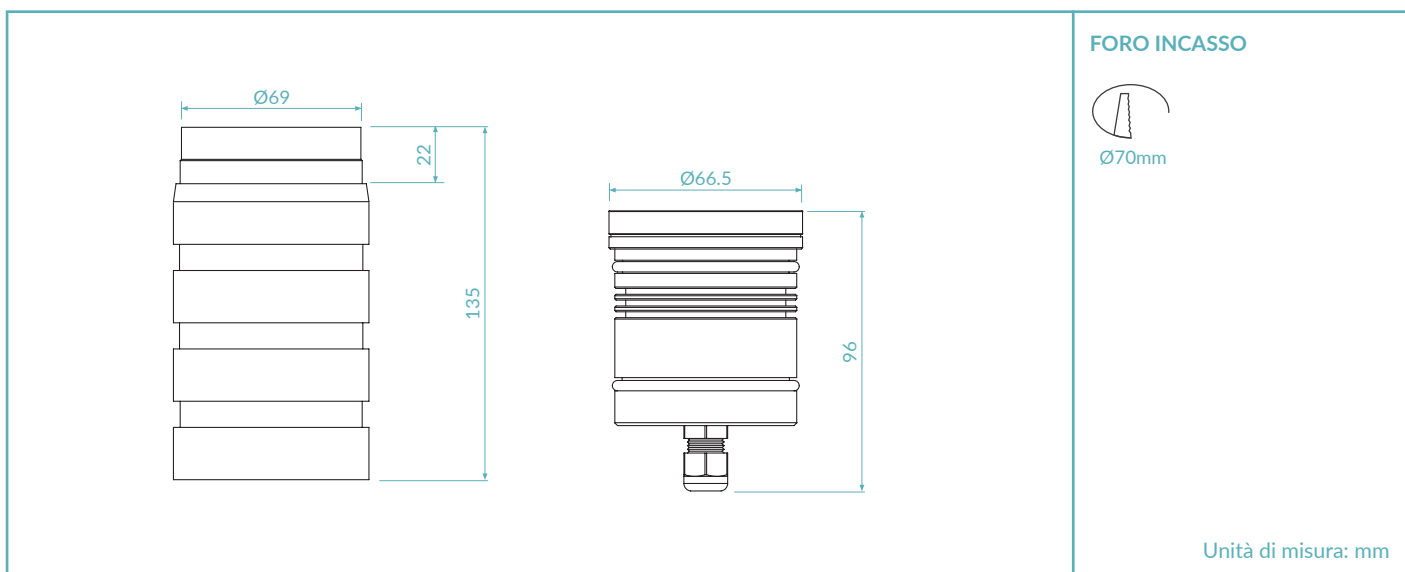

FINITURE

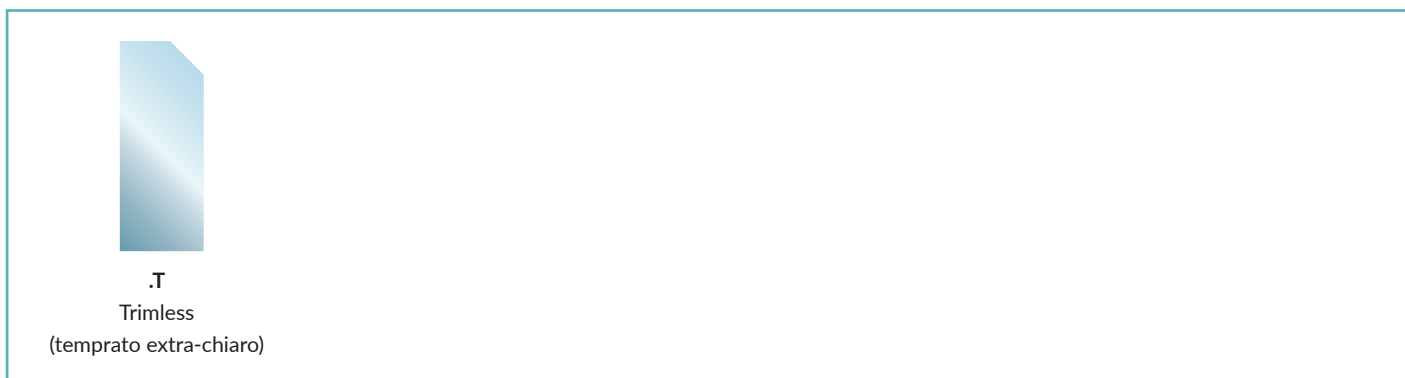

CODICE PRODOTTO

S66 = STELVIO 66

Selezionare un componente per ogni colonna per la configurazione completa:

	Colore LED	Ottiche	Finiture	Potenza
	22 = 2200K 25 = 2450K 27 = 2700K 30 = 3000K 40 = 4000K FC = RGBW DW = Dim to Warm	N = 10° M = 30° (20° DW) (35° RGBW) W = 50° (40° DW) E = 10° x 45° S = Satinato	T = Trimless	05 = 5W 09 = 9W CC = 4x700mA RGBW 350mA-14mA DW

Esempio di configurazione standard:

S66.30.N.T.09 | Stelvio 66 3000K ottica 10° trimless 9W

SCHEDA PRODOTTO

CARATTERISTICHE DI ILLUMINAZIONE

Indice resa cromatica	CRI > 90
Flusso sorgente	630 lm / 840 lm (3000K)
Flusso apparecchio	385 lm / 506 lm (3000K)
Ottiche	10° / 30° / 50° / 10°x 45° / Satinato / 35° RGBW / 20° - 40° DW
Temperatura colore LED	2700K / 3000K / 4000K / RGBW / DW
Vita media LED	50000h L95 B10 (Ta 25°C)
Selezione bin	Binning free 2 step MacAdam's

CARATTERISTICHE MECCANICHE

Corpo	Alluminio 6026 anodizzato
Vetro	Temprato extra chiaro / satinato 8mm
Fissaggio	Cassaforma
Protezione impatto	IK10
Peso	362g











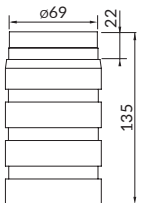

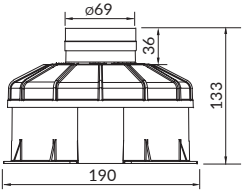
CARATTERISTICHE ELETTRICHE

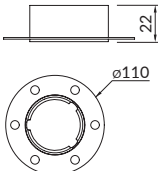
Alimentazione	Tensione costante 24Vdc / Corrente costante 4x700mA RGBW / Corrente costante 350mA - 14mA Dim to Warm
Cavo di alimentazione	35cm NS20N PCP 2x0,5mm ² / 35cm 8x0,22mm ² RGBW
Potenza assorbita	5 Watt / 9 Watt / 9 Watt RGBW / 12 Watt DW
Dimmerazione	Dimmerabile

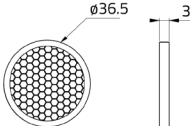
CARATTERISTICHE GENERALI

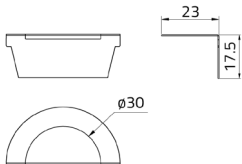
Temperatura di funzionamento	-20°C +50°C
Grado di protezione	IP67
Classe d'isolamento	Classe III
Rischio fotobiologico	RG0/RG1

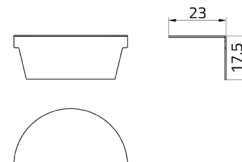
ACCESSORI

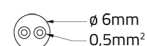
		Cassaforma	Art. Nr. HB.019	
		Cassaforma IP	Art. Nr. HB.020	
		Cassaforma per controsoffitto	Art. Nr. HB.021	
		Schermo alveolare	Art. Nr. ACC.004	
		Frangiluce	Art. Nr. ACC.073	
		Frangiluce	Art. Nr. ACC.088	
		Cavi	Art. Nr. CV00037 CV00040 CV00041 CV00042 CV00043	Lunghezza 5m 10m 15m 20m 25m

ALIMENTATORE TENSIONE COSTANTE 24Vdc

On / Off

Codice	Input	I Out	V Out	Watt	IP
PSU.CX.004	110÷240V / 50/60 Hz	0,9 A	24Vdc	20	IP20
PSU.CV.005	90÷305V / 47/63 Hz	1 A	24Vdc	25	IP67
PSU.CV.006	90÷305V / 47/63 Hz	2,5 A	24Vdc	60	IP67
PSU.CV.007	90÷305V / 47/63 Hz	3,75 A	24Vdc	90	IP67
PSU.CV.021	90÷305V / 47/63 Hz	10 A	24Vdc	240	IP67

Elettronica di controllo

Codice	Input	I Out	V Out	Watt	IP
CGE.004 - 0/1-10V	24Vdc	12 A	24Vdc	288	IP20
CGE.017 - DALI	24Vdc	12 A	24Vdc	288	IP20
CGE.017.IP - DALI	24Vdc	12 A	24Vdc	288	IP67
CGE.020 - DMX	24Vdc	6,5 A	24Vdc	156	IP20

Elettronica di controllo RGBW

Codice	Input	I Out	V Out	Watt	IP
CGE.005 - DMX	24Vdc	4x700mA	24Vdc	67,2	IP20

OTTICHE

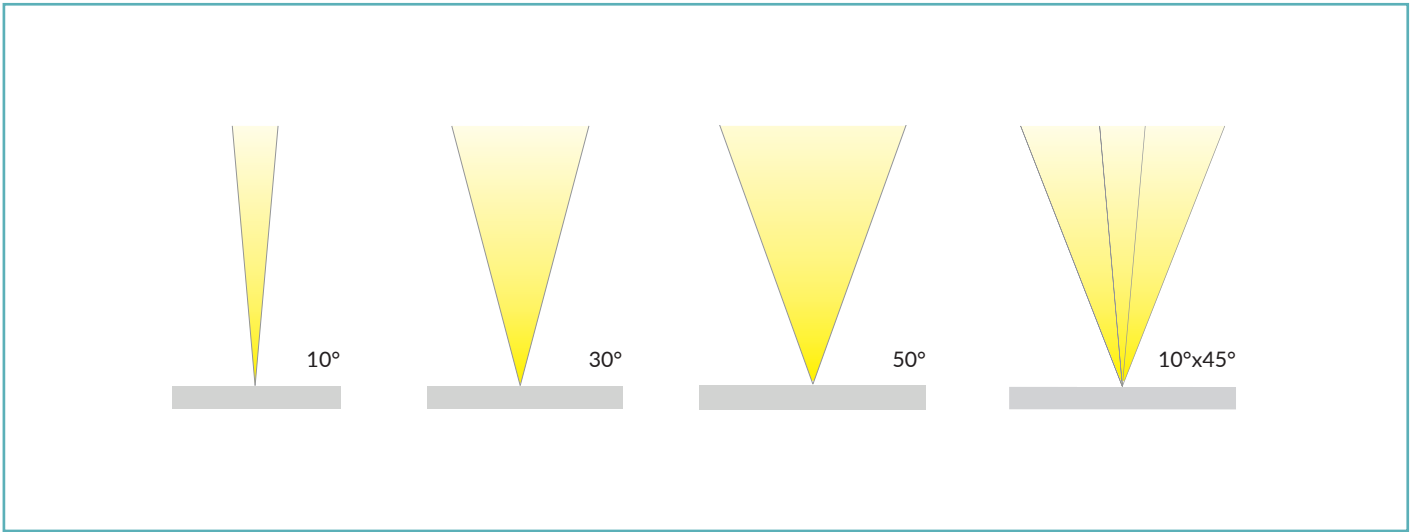

CURVE FOTOMETRICHE

