



STELVIO 66

FICHE TECHNIQUE

INFORMATIONS SUR LE PROJET

Nom du projet:

Référence:

Quantité:



IP67

MADE IN ITALY

DESSIN TECHNIQUE

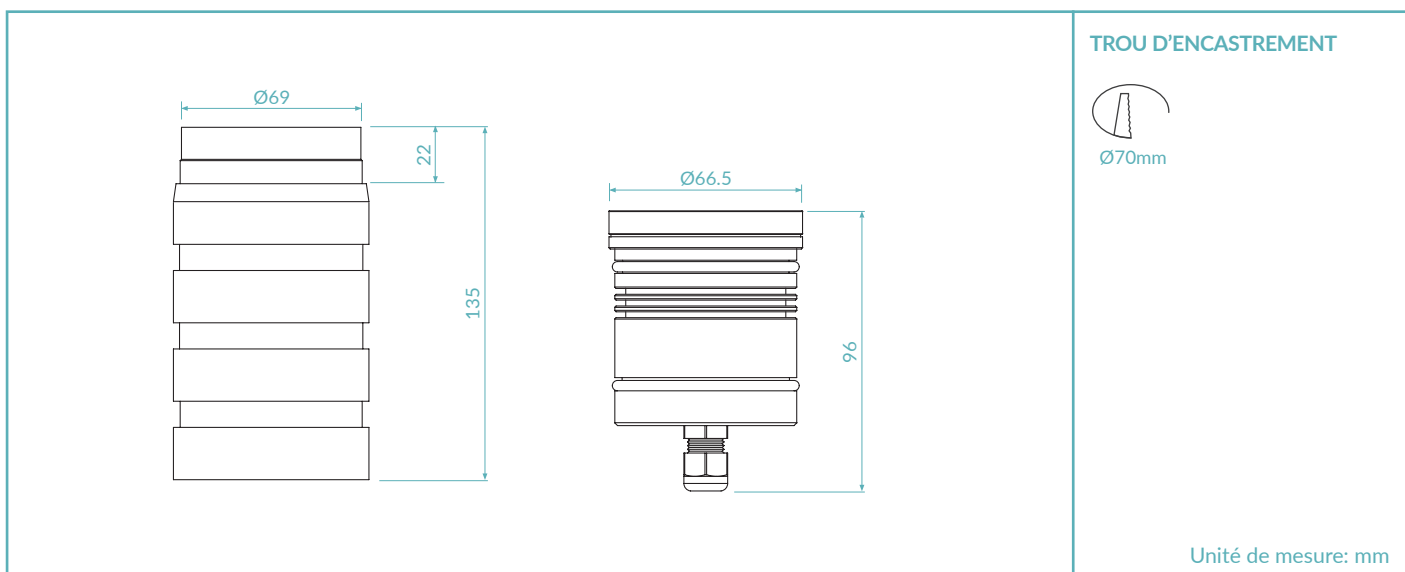

FINITIONS



.T

Trimless

(verre trempé extra-clair)

CODE PRODUIT

S66 = STELVIO 66

Sélectionner un composant pour chaque colonne pour une configuration complète:

	Couleur LED	Optiques	Finitions	Puissance
	22 = 2200K 25 = 2450K 27 = 2700K 30 = 3000K 40 = 4000K FC = RGBW DW = Dim to Warm	N = 10° M = 30° (20° DW) (35° RGBW) W = 50° (40° DW) E = 10° x 45° S = Satiné	T = Trimless	05 = 5W 09 = 9W CC = 4x700mA RGBW 350mA-14mA DW

Exemple de configuration standard:

S66.30.N.T.09 | Stelvio 66 3000K optiques 10° trimless 9W

FICHE PRODUIT

CARACTÉRISTIQUES D'ÉCLAIRAGE

Color Rendering Index	CRI > 90
Flux lumineux (source)	630 lm / 840 lm (3000K)
Flux lumineux (sortant)	385 lm / 506 lm (3000K)
Optiques	10° / 30° / 50° / 10°x 45° / Satiné / 35° RGBW / 20° - 40° DW
Température de couleur LED	2700K / 3000K / 4000K / RGBW / DW
Durée moyenne LED	50000h L95 B10 (Ta 25°C)
Sélection du bin	Binning free 2 step MacAdam's

CARACTÉRISTIQUES MÉCANIQUES

Corp	Alluminium 6026 anodisé
Verre	Verre trempé extra clair / satiné 8mm
Installations	Boîtier d'encastrement
Indice de résistance	IK10
Poids	362g

CARACTÉRISTIQUES ÉLECTRIQUES

Alimentation	Tension constante 24Vdc / Courant constante 4x700mA RGBW / Courant constante 350mA - 14mA Dim to Warm
Câbles d'alimentations	35cm NS20N PCP 2x0,5mm ² / 35cm 8x0,22mm ² RGBW
Puissance absorbée	5 Watt / 9 Watt / 9 Watt RGBW / 12 Watt DW
Dimmable	Dimmable

CARACTÉRISTIQUES GÉNÉRALES

Temperature de fonctionnement	-20°C +50°C
Indice de protection	IP67
Classe d'isolation	Classe III
Sécurité photobiologique	RG0/RG1

ACCESSOIRES

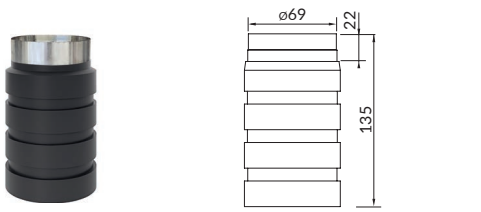

Boîtier d'encastrement **Art. Nr. HB.019**

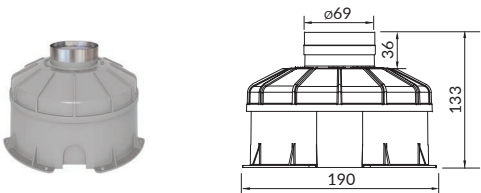

Boîtier d'encastrement **Art. Nr. HB.020**
IP

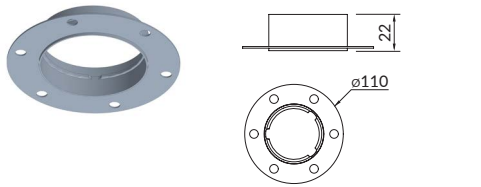

Boîtier d'encastrement **Art. Nr. HB.021**
pour plafond suspendu

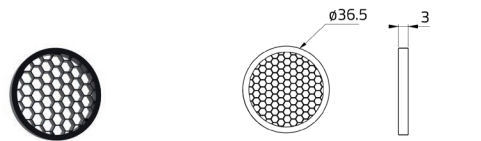

Grille nid d'abeille **Art. Nr. ACC.004**

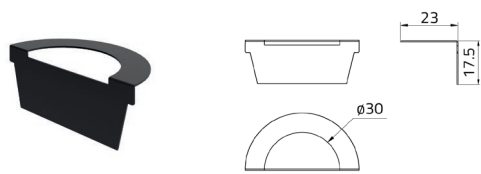

Visière anti-éblouissement **Art. Nr. ACC.073**



Visière anti-éblouissement **Art. Nr. ACC.088**



Câble	Art. Nr.	Longueur
	CV00037	5m
	CV00040	10m
	CV00041	15m
	CV00042	20m
CV00043	25m	

ALIMENTATEUR TENSION CONSTANTE 24Vdc

On / Off

Code	Input	I Out	V Out	Watt	IP
PSU.CX.004	110÷240V / 50/60 Hz	0,9 A	24Vdc	20	IP20
PSU.CV.005	90÷305V / 47/63 Hz	1 A	24Vdc	25	IP67
PSU.CV.006	90÷305V / 47/63 Hz	2,5 A	24Vdc	60	IP67
PSU.CV.007	90÷305V / 47/63 Hz	3,75 A	24Vdc	90	IP67
PSU.CV.021	90÷305V / 47/63 Hz	10 A	24Vdc	240	IP67

Système de control

Code	Input	I Out	V Out	Watt	IP
CGE.004 - 0/1-10V	24Vdc	12 A	24Vdc	288	IP20
CGE.017 - DALI	24Vdc	12 A	24Vdc	288	IP20
CGE.017.IP - DALI	24Vdc	12 A	24Vdc	288	IP67
CGE.020 - DMX	24Vdc	6,5 A	24Vdc	156	IP20

Système de control RGBW

Code	Input	I Out	V Out	Watt	IP
CGE.005 - DMX	24Vdc	4x700mA	24Vdc	67,2	IP20

OPTIQUES

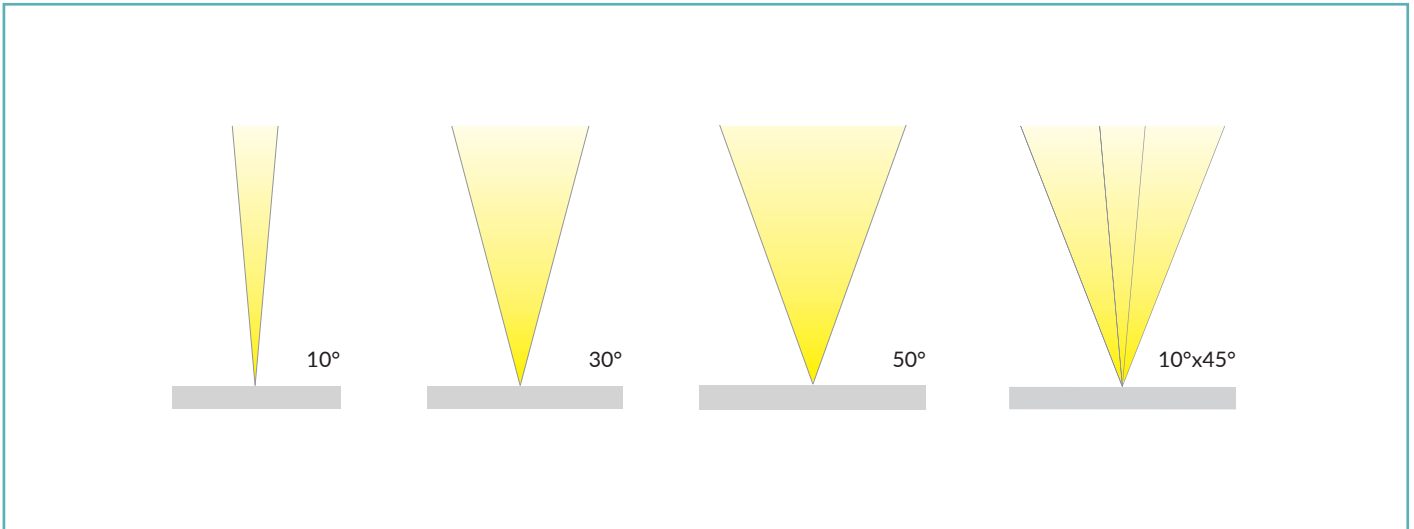

PHOTOMÉTRIE

