



STELVIO 66

TECHNICAL DATASHEET

PROJECT INFORMATION

Project Name:

Reference:

Quantity:



IP67

MADE IN ITALY

TECHNICAL DRAWING

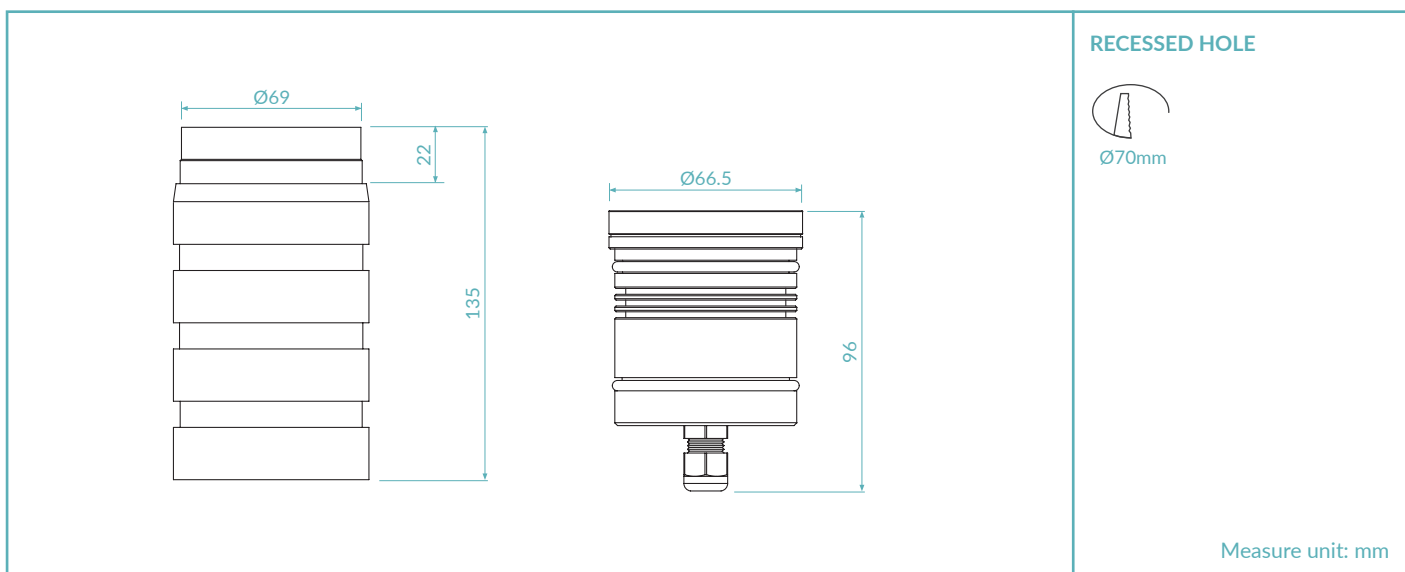

FINISHES



.T

Trimless

(tempered extra-clear glass)

PRODUCT CODE

S66 = STELVIO 66

Select one component from each column to specify a complete configuration:

	LED colour	Optics	Finish	Power
	22 = 2200K 25 = 2450K 27 = 2700K 30 = 3000K 40 = 4000K FC = RGBW DW = Dim to Warm	N = 10° M = 30° (20° DW) (35° RGBW) W = 50° (40° DW) E = 10° x 45° S = Satin	T = Trimless	05 = 5W 09 = 9W CC = 4x700mA RGBW 350mA-14mA DW

Standard configuration example:

S66.30.N.T.09 | Stelvio 66 3000K 10° optics trimless 9W

TECHNICAL SHEET

LIGHTING CHARACTERISTICS

Color Rendering Index	CRI > 90
Lumen output (source)	630 lm / 840 lm (3000K)
Lumen output (delivered)	385 lm / 506 lm (3000K)
Optics	10° / 30° / 50° / 10°x 45° / Satin / 35° RGBW / 20° - 40° DW
LED colour temperature	2200K / 2450K / 2700K / 3000K / 4000K / RGBW / DW
LED lifetime	50000h L95 B10 (Ta 25°C)
Bin selection	Binning free 2 step MacAdam's

MECHANICAL CHARACTERISTICS

Body	Anodized aluminium 6026
Glass	Tempered extra-clear / frosted glass 8mm
Installation	Housing box
Impact resistance	IK10
Weight	362g











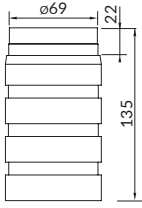

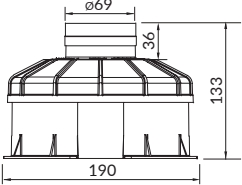
ELECTRICAL CHARACTERISTICS

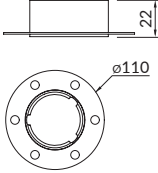
Power supply	Constant voltage 24Vdc / Constant current 4x700mA RGBW / Constant current 350mA - 14mA Dim to Warm
Power supply cables	35cm NS20N PCP 2x0,5mm ² / 35cm 8x0,22mm ² RGBW
Power consumption	5 Watt / 9 Watt / 9 Watt RGBW / 12 Watt DW
Dimmable	Dimmable

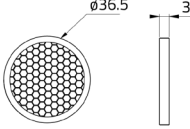
GENERAL CHARACTERISTICS

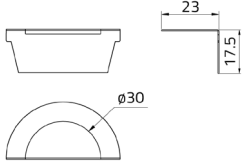
Operating temperature	-20°C +50°C
IP rating	IP67
Insulation class	Class III
Photobiological risk	RG0/RG1

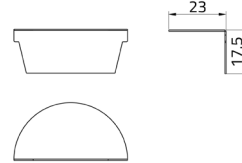
ACCESSORIES

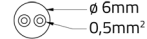
		Housing box	Art. Nr. HB.019	
		Housing box IP	Art. Nr. HB.020	
		False ceiling housing box	Art. Nr. HB.021	
		Honeycomb louver	Art. Nr. ACC.004	
		Anti-Glare louver	Art. Nr. ACC.073	
		Anti-Glare louver	Art. Nr. ACC.088	
		Cable	Art. Nr. CV00037 CV00040 CV00041 CV00042 CV00043	Length 5m 10m 15m 20m 25m

POWER SUPPLIES 24Vdc CONSTANT VOLTAGE

On / Off

Code	Input	I Out	V Out	Watt	IP
PSU.CX.004	110÷240V / 50/60 Hz	0,9 A	24Vdc	20	IP20
PSU.CV.005	90÷305V / 47/63 Hz	1 A	24Vdc	25	IP67
PSU.CV.006	90÷305V / 47/63 Hz	2,5 A	24Vdc	60	IP67
PSU.CV.007	90÷305V / 47/63 Hz	3,75 A	24Vdc	90	IP67
PSU.CV.021	90÷305V / 47/63 Hz	10 A	24Vdc	240	IP67

Control Gear

Code	Input	I Out	V Out	Watt	IP
CGE.004 - 0/1-10V	24Vdc	12 A	24Vdc	288	IP20
CGE.017 - DALI	24Vdc	12 A	24Vdc	288	IP20
CGE.017.IP - DALI	24Vdc	12 A	24Vdc	288	IP67
CGE.020 - DMX	24Vdc	6,5 A	24Vdc	156	IP20

Control Gear RGBW

Code	Input	I Out	V Out	Watt	IP
CGE.005 - DMX	24Vdc	4x700mA	24Vdc	67,2	IP20

OPTICS

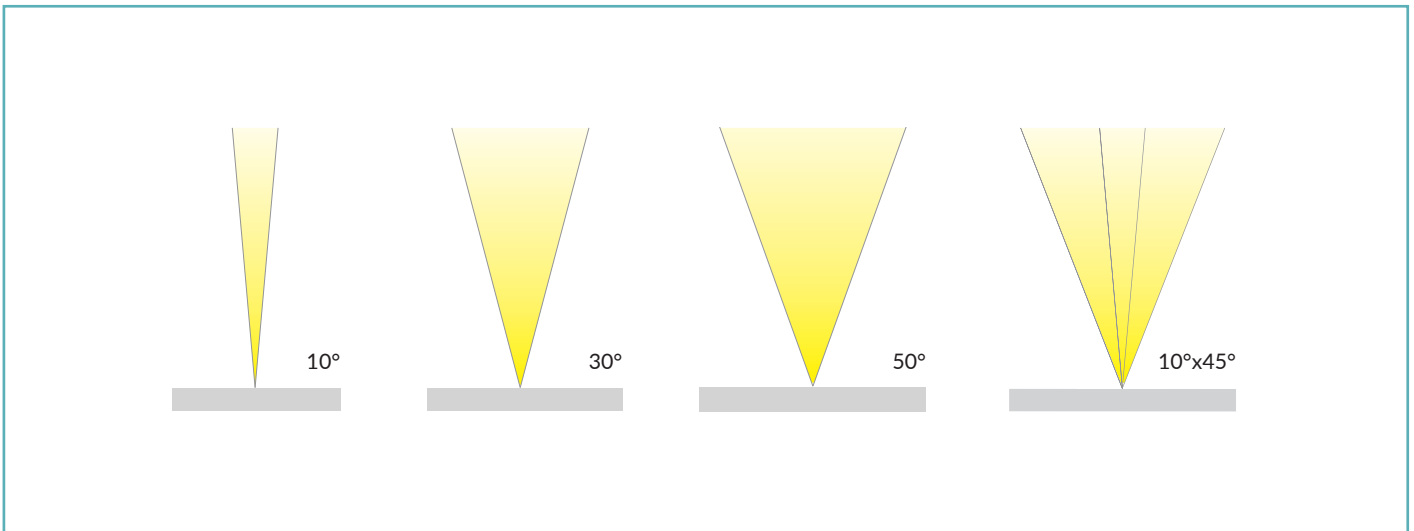

PHOTOMETRICS

