



SLASH 30

TECHNICAL DATASHEET

PROJECT INFORMATION

Project Name:

Reference:

Quantity:



TECHNICAL DRAWING

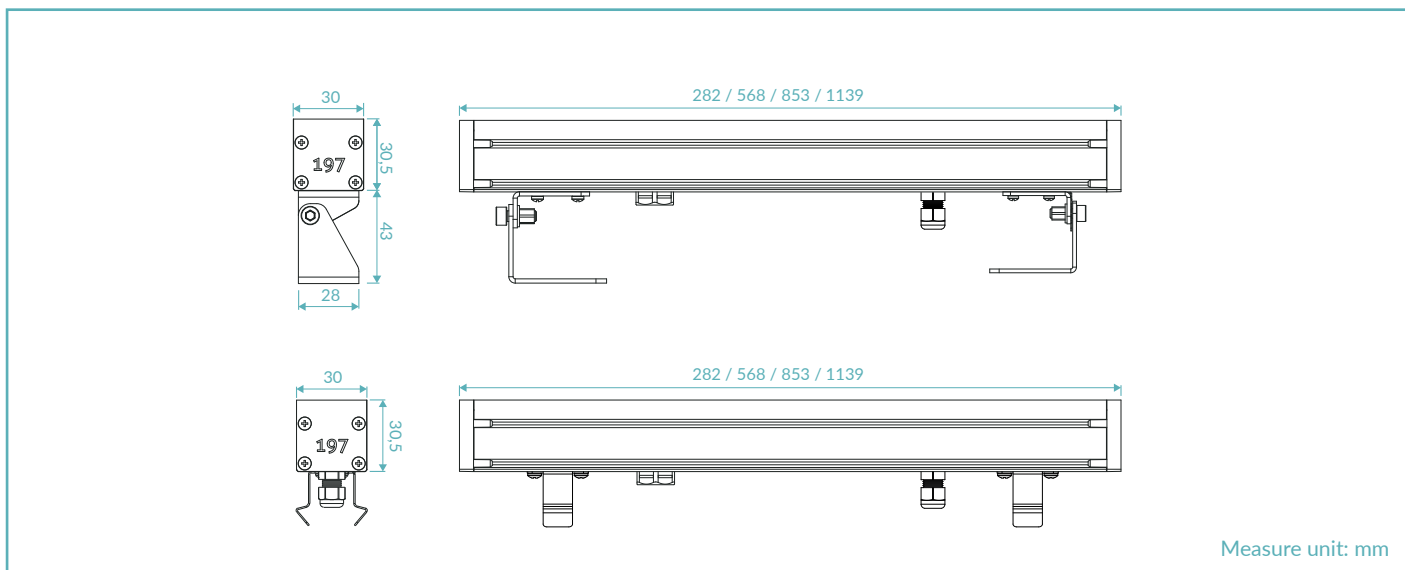

FINISHES



.07
Natural anodized

PRODUCT CODE

S30A = SLASH 30 P5

Select one component from each column to specify a complete configuration:

LED colour	Optics	Finish	Length	Power
22 = 2200K 27 = 2700K 30 = 3000K 40 = 4000K	N = 12° M = 21° W = 31° F = 46° E = 13° x 36°	07 = Natural anodized	02 = 282 mm 05 = 568 mm 08 = 853 mm 11 = 1139 mm	06 = 6,4W 13 = 13,4W 12 = 12,8W 26 = 26,8W 19 = 19,2W 40 = 40,2W 25 = 25,6W 53 = 53,6W



Standard configuration example:

S30A.30.M.07.05.12 | Slash 30 P5 3000K 21° optics natural anodized 568mm 12,8W

TECHNICAL SHEET

LIGHTING CHARACTERISTICS

Color Rendering Index	> 90				
Lumen output (3000K)	Length	1W x LED		2W x LED	
	282mm	630 lm source 535 lm delivered 6,4W		1140 lm source 696 lm delivered 13,4W	
	568mm	1260 lm source 1071 lm delivered 12,8W		2280 lm source 1938 lm delivered 26,8W	
	853mm	1890 lm source 1606 lm delivered 19,2W		3420 lm source 2907 lm delivered 40,2W	
	1139mm	2520 lm source 2142 lm delivered 25,6W		4560 lm source 3876 lm delivered 53,6W	
Optics	12° / 21° / 31° / 46° / 13°x36°				
LED colour temperature	2200K / 2700K / 3000K / 4000K				
LED lifetime	50000h L95 B10 (Ta 25°C)				
Bin selection	Binning free 2 step MacAdam's				

MECHANICAL CHARACTERISTICS

Body	Extruded aluminium 6026			
Glass	Half frosted tempered glass			
Finishes	Natural anodized			
Installation	Housing box / Fixing brackets			
Impact resistance	IK06			
Dimensions & Weight	282mm	460g	853mm	1,3Kg
	568mm	880g	1139mm	1,72Kg

ELECTRICAL CHARACTERISTICS

Power supply	Constant voltage 24Vdc
Power supply cables	30cm with IP68 Easy-Lock connector

GENERAL CHARACTERISTICS

Operating temperature	-20°C +50°C
IP rating	IP67
Insulation class	Class III
Photobiological risk	RG0 / RG1

PRODUCT CODE

S30B = SLASH 30 P10

Select one component from each column to specify a complete configuration:

LED colour	Optics	Finish	Length	Power
22 = 2200K 27 = 2700K 30 = 3000K 40 = 4000K	N = 12° M = 21° W = 31° F = 46° E = 13° x 36°	07 = Natural anodized	02 = 282 mm 05 = 568 mm 08 = 853 mm 11 = 1139 mm	03 = 3,5W 07 = 7W 10 = 10,5W 15 = 15W 07 = 7,1W 14 = 14,2W 21 = 21,3W 30 = 30W

Standard configuration example:

S30B.30.M.07.05.03 | Slash 30 P10 3000K 21° optics natural anodized 568mm 3,5W

TECHNICAL SHEET

LIGHTING CHARACTERISTICS

Color Rendering Index	> 90				
Lumen output (3000K)	Length	1W x LED		2W x LED	
	282mm	315 lm source 268 lm delivered		570 lm source 485 lm delivered	
	568mm	3,5W	7W	7,1W	14,2W
	853mm	630 lm source 536 lm delivered		1140 lm source 969 lm delivered	
	1139mm	10,5W	15W	21,3W	30W
Optics	12° / 21° / 31° / 46° / 13°x36°				
LED colour temperature	2200K / 2700K / 3000K / 4000K				
LED lifetime	50000h L95 B10 (Ta 25°C)				
Bin selection	Binning free 2 step MacAdam's				

MECHANICAL CHARACTERISTICS

Body	Extruded aluminium 6026			
Glass	Half frosted tempered glass			
Finishes	Natural anodized			
Installation	Housing box / Fixing brackets			
Impact resistance	IK06			
Dimensions & Weight	282mm	460g	853mm	1,3Kg
	568mm	880g	1139mm	1,72Kg

ELECTRICAL CHARACTERISTICS

Power supply	Constant voltage 24Vdc
Power supply cables	30cm with IP68 Easy-Lock connector

GENERAL CHARACTERISTICS

Operating temperature	-20°C +50°C
IP rating	IP67
Insulation class	Class III
Photobiological risk	RG0 / RG1

PRODUCT CODE

S30R = SLASH 30 RGBW

Select one component from each column to specify a complete configuration:

	LED colour	Optics	Finish	Length	Power
	FC = RGBW	N = 12° M = 25° W = 37°	07 = Natural anodized	02 = 282 mm 05 = 568 mm 08 = 853 mm 11 = 1139 mm	14 = 14W 28 = 28W 42 = 42W 56 = 56W

Standard configuration example:

S30R.FC.M.07.05.14 | Slash 30 RGBW 3000K 25° optics natural anodized 568mm 14W

TECHNICAL SHEET

LIGHTING CHARACTERISTICS

Color Rendering Index	> 90				
Lumen output	Length	Red	Green	Blue	White
	282mm	222 lm source 189 lm delivered	468 lm source 397 lm delivered	138 lm source 118 lm delivered	264 lm source 225 lm delivered
		568mm	444 lm source 378 lm delivered	936 lm source 794 lm delivered	276 lm source 236 lm delivered
	853mm		666 lm source 567 lm delivered	1404 lm source 1191 lm delivered	414 lm source 354 lm delivered
		1139mm	888 lm source 756 lm delivered	1872 lm source 1588 lm delivered	552 lm source 472 lm delivered
Optics	12° / 25° / 37°				
LED lifetime	50000h L95 B10 (Ta 25°C)				
Bin selection	Binning free 2 step MacAdam's				

MECHANICAL CHARACTERISTICS

Body	Extruded aluminium 6026			
Glass	Half frosted tempered glass			
Finishes	Natural anodized			
Installation	Housing box / Fixing brackets			
Impact resistance	IK06			
Dimensions & Weight	282mm	460g	853mm	1,3Kg
	568mm	880g	1139mm	1,72Kg

ELECTRICAL CHARACTERISTICS

Power supply	Constant voltage 24Vdc			
Power supply cables	30cm with IP68 Easy-Lock connector			
Power consumption	282mm	14W	853mm	42W
	568mm	28W	1139mm	56W

GENERAL CHARACTERISTICS

Operating temperature	-20°C +50°C
IP rating	IP67
Insulation class	Class III
Photobiological risk	RG0 / RG1

PRODUCT CODE

<p>S30T = SLASH 30 TW</p> 	Select one component from each column to specify a complete configuration:			
	LED colour	Optics	Finish	Length
TW = Tunable white	N = 12° M = 25° W = 37°	07 = Natural anodized	02 = 282 mm 05 = 568 mm 08 = 853 mm 11 = 1139 mm	14 = 14W 28 = 28W 42 = 42W 56 = 56W

Standard configuration example:

S30T.TW.M.07.05.14 | Slash 30 TW 3000K 25° optics natural anodized 568mm 14W

LIGHTING CHARACTERISTICS

Color Rendering Index	> 90		
Lumen output	Length	2700K	4000K
	282mm	240 lm source 204 lm delivered	340 lm source 289 lm delivered
	568mm	480 lm source 408 lm delivered	680 lm source 578 lm delivered
	853mm	720 lm source 612 lm delivered	1020 lm source 867 lm delivered
Optics	12° / 25° / 37°		
	LED colour temperature	2700K / 4000K	
LED lifetime	50000h L95 B10 (Ta 25°C)		
Bin selection	Binning free 2 step MacAdam's		

MECHANICAL CHARACTERISTICS

Body	Extruded aluminium 6026			
Glass	Half frosted tempered glass			
Finishes	Natural anodized			
Installation	Housing box / Fixing brackets			
Impact resistance	IK06			
Dimensions & Weight	282mm	460g	853mm	1,3Kg
	568mm	880g	1139mm	1,72Kg

ELECTRICAL CHARACTERISTICS

Power supply	Constant voltage 24Vdc			
Power supply cables	30cm with IP68 Easy-Lock connector			
Power consumption	282mm	14W	853mm	42W
	568mm	28W	1139mm	56W

GENERAL CHARACTERISTICS

Operating temperature	-20°C +50°C
IP rating	IP67
Insulation class	Class III
Photobiological risk	RG0 / RG1

ACCESSORIES

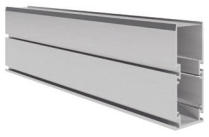
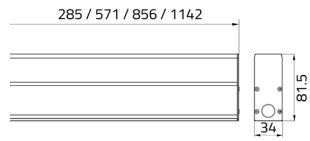
Housing box

Art. Nr.
HB.010

Length
.0282 = 282mm
.0568 = 568mm
.0853 = 853mm
.1139 = 1139mm

Flanged housing box

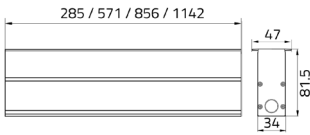
Art. Nr.
HB.015

Length
.0282 = 282mm
.0568 = 568mm
.0853 = 853mm
.1139 = 1139mm



H 23 mm

Anti-Glare louver

Art. Nr.
ACC.130

Length
.0282 = 282mm
.0568 = 568mm
.0853 = 853mm
.1139 = 1139mm



H 23 mm

Clear glass

Art. Nr.
ACC.142

Length
.0282 = 282mm
.0568 = 568mm
.0853 = 853mm
.1139 = 1139mm

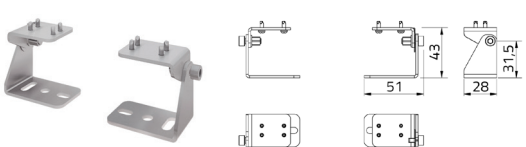

Fixing bracket

Art. Nr.
ACC.125

Finishes
.07 = Natural anodized

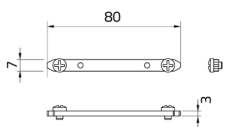
Housing box alignment kit

Art. Nr.
ACC.093

ACCESSORIES

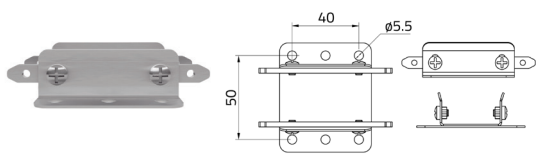

Housing box fixing kit

Art. Nr.
ACC.094

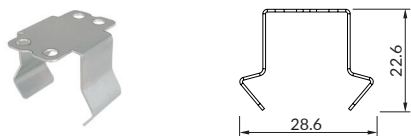

Fixing springs
for housing box
installation (couple)

Art. Nr.
ACC.159



Leader cable 5m

Art. Nr.
ACC.057

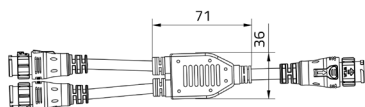

Y connection cable
75cm

Art. Nr.
ACC.058

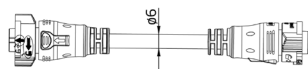

Extension cable 1m

Art. Nr.
ACC.059

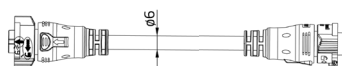

Extension cable 2m

Art. Nr.
ACC.131

POWER SUPPLIES 24Vdc CONSTANT VOLTAGE

On / Off

Code	Input	I Out	V Out	Watt	IP
PSU.CX.004	110÷240V / 50/60 Hz	0,9 A	24Vdc	20	IP20
PSU.CV.005	90÷305V / 47/63 Hz	1 A	24Vdc	25	IP67
PSU.CV.006	90÷305V / 47/63 Hz	2,5 A	24Vdc	60	IP67
PSU.CV.007	90÷305V / 47/63 Hz	3,75 A	24Vdc	90	IP67
PSU.CV.021	90÷305V / 47/63 Hz	10 A	24Vdc	240	IP67

Control Gear

Code	Input	I Out	V Out	Watt	IP
CGE.004 - 0/1-10V	24Vdc	6,5 A	24Vdc	156	IP20
CGE.017 - DALI	24Vdc	6,5 A	24Vdc	156	IP20
CGE.017.IP - DALI	24Vdc	6,5 A	24Vdc	156	IP67
CGE.020 - DMX	24Vdc	6,5 A	24Vdc	156	IP20

Control Gear RGBW / TW

Code	Input	I Out	V Out	Watt	IP
CGE.016 - DALI RGBW / TW	24Vdc	4x5 A	24Vdc	480	IP20
CGE.019 - DMX RGBW / TW	24Vdc	4x5 A	24Vdc	480	IP20

OPTICS

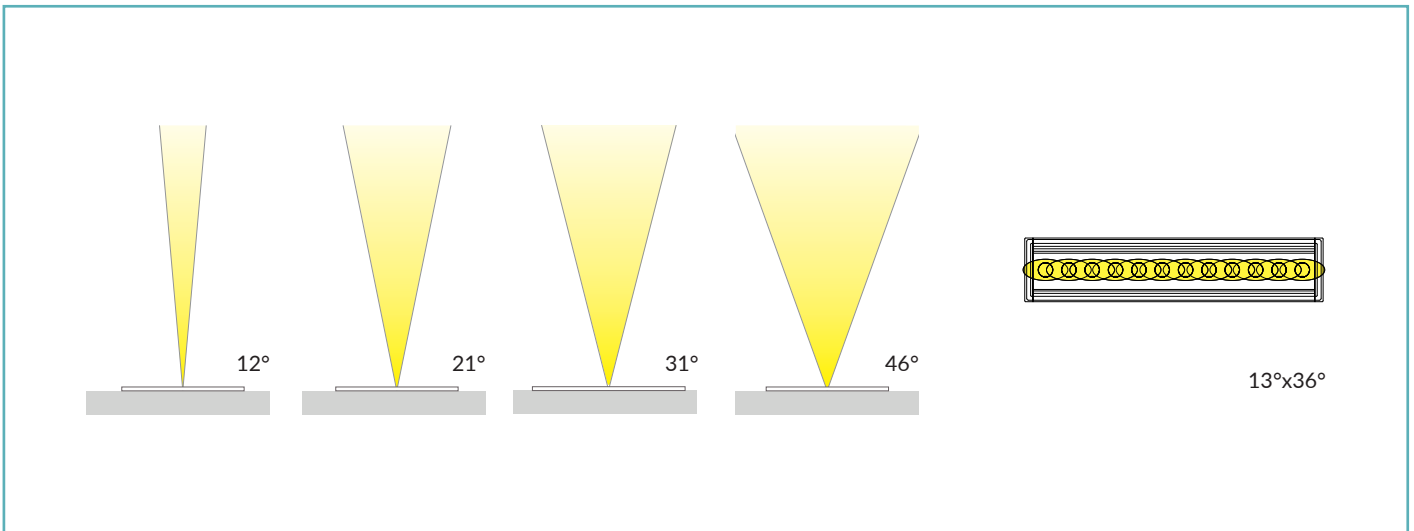

PHOTOMETRICS

