



CALIBER 80 Q

FICHE TECHNIQUE

INFORMATIONS SUR LE PROJET

Nom du projet:

Référence:

Quantité:



MADE IN ITALY

DESSIN TECHNIQUE

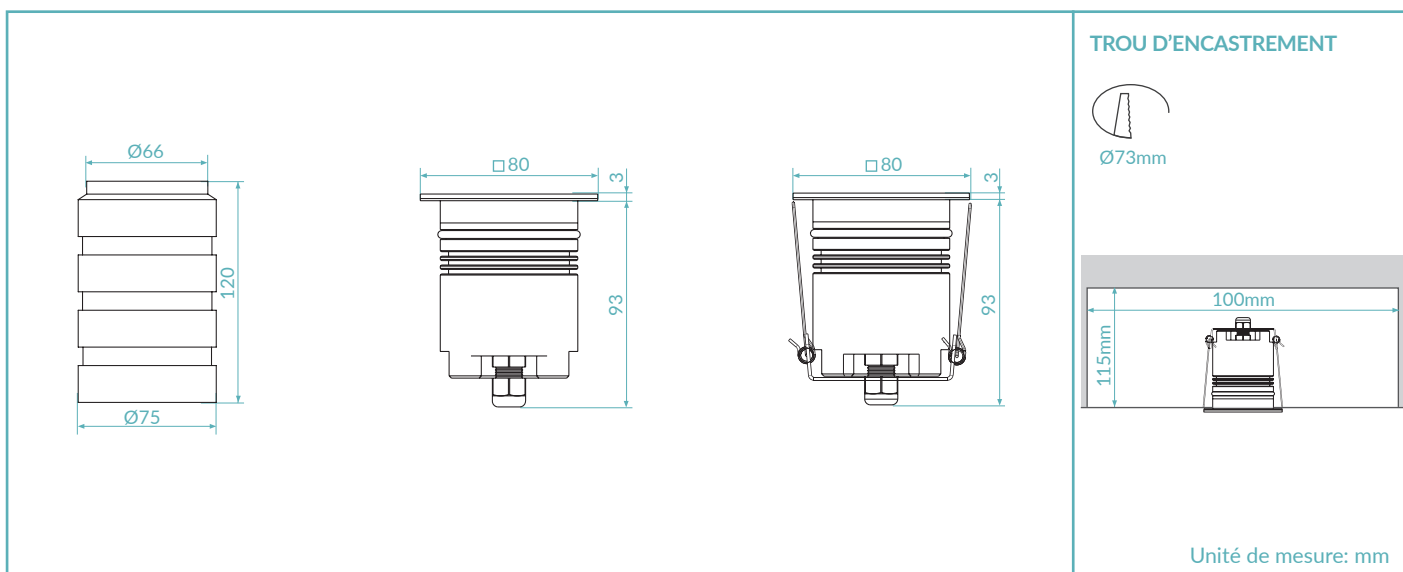

FINISHES



.03
Acier INOX AISI316L

PRODUCT CODE

C8Q = CALIBER 80 Q

Sélectionner un composant pour chaque colonne pour une configuration complète:

	Couleur LED	Optiques	Finitions	Puissance
	27 = 2700K 30 = 3000K 40 = 4000K FC = RGBW	N = 10° M = 30° (35° RGBW) W = 50° S = Satiné	03 = Acier INOX AISI316L	05 = 5W 09 = 9W CC = 4x700mA RGBW

Exemple de configuration standard:

C8Q.30.N.03.09 | Caliber 80 Q 3000K optiques 10° acier INOX 9W

FICHE PRODUIT

CARACTÉRISTIQUES D'ÉCLAIRAGE

Color Rendering Index	CRI > 90
Flux lumineux (source)	647 lm / 896 lm (3000K)
Flux lumineux (sortant)	409 lm / 590 lm (3000K)
Optiques	10° / 30° / 50° / Satiné / 35° RGBW
Température de couleur LED	2700K / 3000K / 4000K / RGBW
Durée moyenne LED	50000h L95 B10 (Ta 25°C)
Sélection du bin	Binning free 2 step MacAdam's

CARACTÉRISTIQUES MÉCANIQUES

Corp	Acier INOX AISI316L - Alluminium 6026 anodisé
Verre	Verre trempé extra clair / satiné 6mm
Finitions	Acier INOX AISI316L
Installations	Boîtier d'encastrement / Ressorts de montage
Indice de résistance	IK08
Poids	640g

CARACTÉRISTIQUES ÉLECTRIQUES

Alimentation	Tension constante 24Vdc / Courant constante 4x700mA RGBW
Câbles d'alimentations	35cm NS20N PCP 2x0,5mm ² / 35cm 8x0,22mm ² RGBW
Puissance absorbée	5 Watt / 9 Watt / 9 Watt RGBW
Dimmable	Dimmable

CARACTÉRISTIQUES GÉNÉRALES

Temperature de fonctionnement	-20°C +50°C
Indice de protection	IP68
Classe d'isolation	Classe III
Sécurité photobiologique	RG0/RG1

ACCESSOIRES

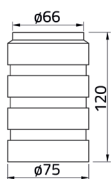

Boîtier d'encastrement **Art. Nr. HB.003**

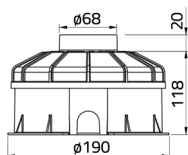

Boîtier d'encastrement **Art. Nr. HB.014**
IP

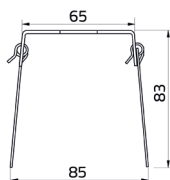

Ressorts de montage **Art. Nr. ACC.007**

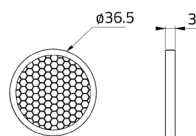

Grille nid d'abeille **Art. Nr. ACC.004**

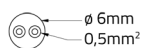

Câble	Art. Nr.	Longueur
	CV00037	5m
	CV00040	10m
	CV00041	15m
	CV00042	20m
	CV00043	25m

ALIMENTATEUR TENSION CONSTANTE 24Vdc

On / Off

Code	Input	I Out	V Out	Watt	IP
PSU.CX.004	110÷240V / 50/60 Hz	0,9 A	24Vdc	20	IP20
PSU.CV.005	90÷305V / 47/63 Hz	1 A	24Vdc	25	IP67
PSU.CV.006	90÷305V / 47/63 Hz	2,5 A	24Vdc	60	IP67
PSU.CV.007	90÷305V / 47/63 Hz	3,75 A	24Vdc	90	IP67
PSU.CV.021	90÷305V / 47/63 Hz	10 A	24Vdc	240	IP67

Système de control

Code	Input	I Out	V Out	Watt	IP
CGE.004 - 0/1-10V	24Vdc	6,5 A	24Vdc	156	IP20
CGE.017 - DALI	24Vdc	6,5 A	24Vdc	156	IP20
CGE.017.IP - DALI	24Vdc	6,5 A	24Vdc	156	IP67
CGE.020 - DMX	24Vdc	6,5 A	24Vdc	156	IP20

Système de control RGBW

Code	Input	I Out	V Out	Watt	IP
CGE.005 - DMX	24Vdc	4x700 mA	24Vdc	67,2	IP20

OPTIQUES

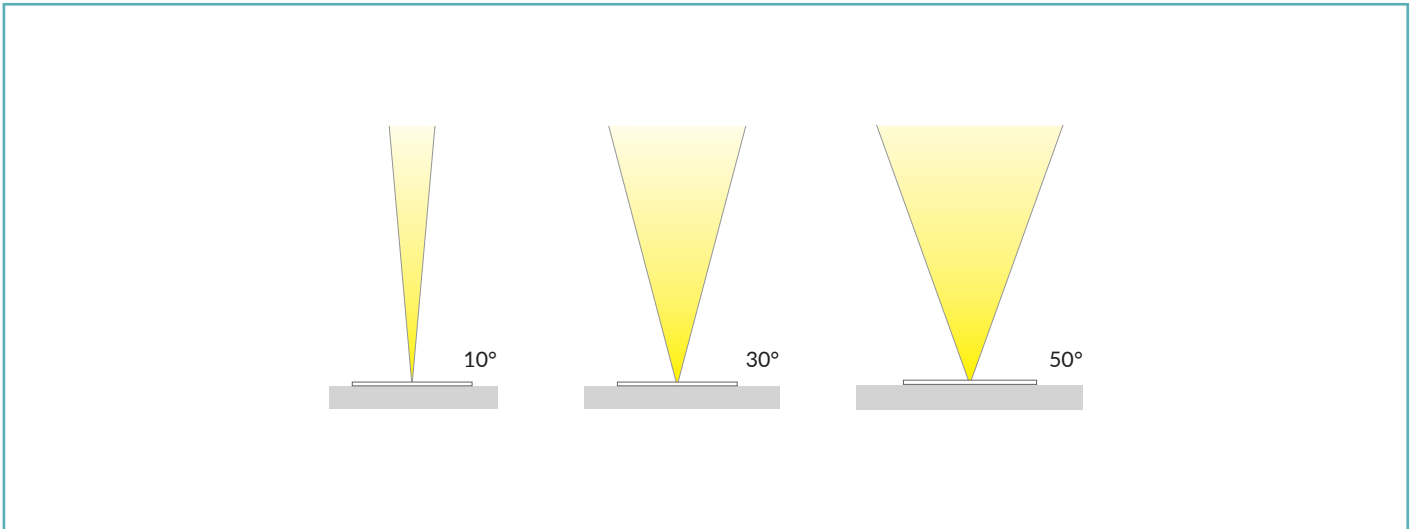

PHOTOMÉTRIE

