



CALIBER 80 Q

TECHNICAL DATASHEET

PROJECT INFORMATION

Project Name:

Reference:

Quantity:



IP68
MADE IN ITALY

TECHNICAL DRAWING

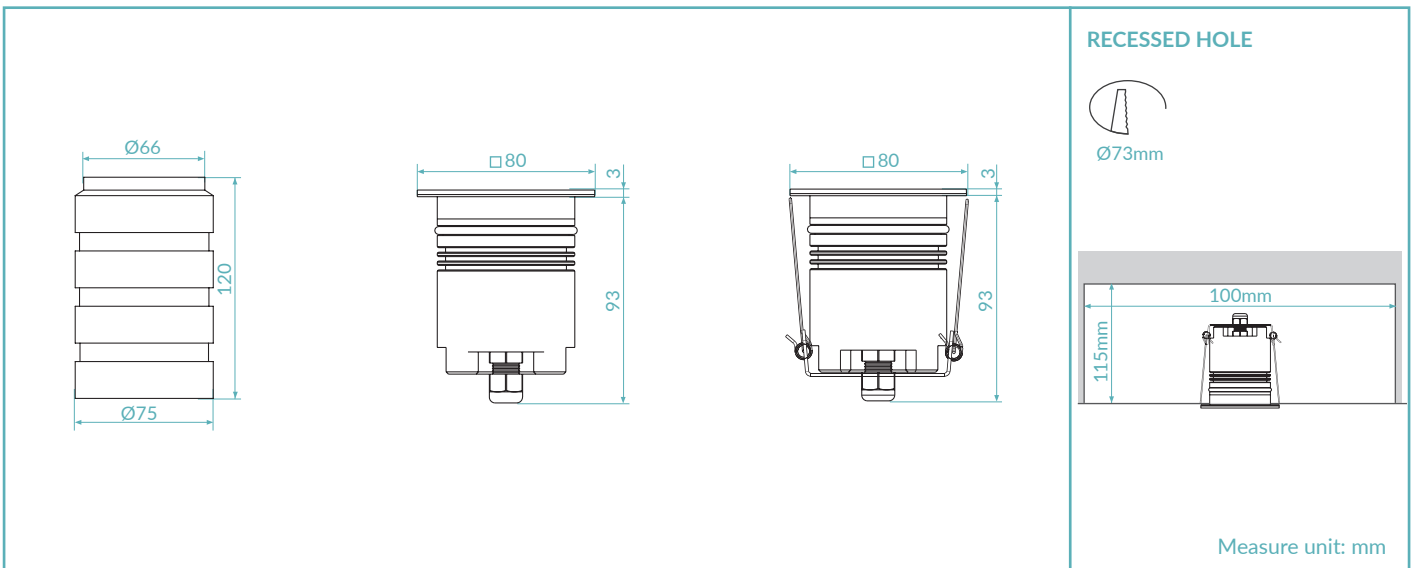

FINISHES



.03
Stainless steel AISI316L

PRODUCT CODE

<p>C8Q = CALIBER 80 Q</p> 	Select one component from each column to specify a complete configuration:		
	LED colour	Optics	Finish
27 = 2700K 30 = 3000K 40 = 4000K FC = RGBW	N = 10° M = 30° (35° RGBW) W = 50° S = Satin	03 = Stainless steel AISI316L	05 = 5W 09 = 9W CC = 4x700mA RGBW

Standard configuration example:

C8Q.30.N.03.09 | Caliber 80 Q 3000K 10° optics stainless steel 9W

TECHNICAL SHEET

LIGHTING CHARACTERISTICS

Color Rendering Index	CRI > 90
Lumen output (source)	647 lm / 896 lm (3000K)
Lumen output (delivered)	409 lm / 590 lm (3000K)
Optics	10° / 30° / 50° / Satin / 35° RGBW
LED colour temperature	2700K / 3000K / 4000K / RGBW
LED lifetime	50000h L95 B10 (Ta 25°C)
Bin selection	Binning free 2 step MacAdam's

MECHANICAL CHARACTERISTICS

Body	Stainless Steel AISI316L - Anodized aluminium 6026
Glass	Tempered extra clear / frosted glass 6 mm
Finishes	Stainless Steel AISI316L
Installation	Housing box / Fixing Springs
Impact resistance	IK08
Weight	640g

ELECTRICAL CHARACTERISTICS

Power supply	Constant voltage 24Vdc / Constant current 4x700mA RGBW
Power supply cables	35cm NS20N PCP 2x0,5mm ² / 35cm 8x0,22mm ² RGBW
Power consumption	5 Watt / 9 Watt / 9 Watt RGBW
Dimmable	Dimmable

GENERAL CHARACTERISTICS

Operating temperature	-20°C +50°C
IP rating	IP68
Insulation class	Class III
Photobiological risk	RG0/RG1

ACCESSORIES

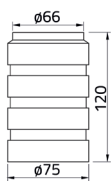

Housing box

Art. Nr.
HB.003

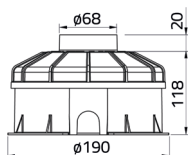

Housing box IP

Art. Nr.
HB.014

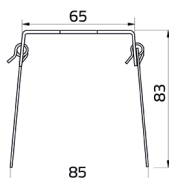

Fixing springs

Art. Nr.
ACC.007

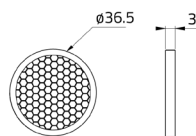

Honeycomb louver

Art. Nr.
ACC.004

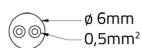

Cable

Art. Nr.
CV00037
CV00040
CV00041
CV00042
CV00043

Length

5m
10m
15m
20m
25m

POWER SUPPLIES 24Vdc CONSTANT VOLTAGE

On / Off

Code	Input	I Out	V Out	Watt	IP
PSU.CX.004	110÷240V / 50/60 Hz	0,9 A	24Vdc	20	IP20
PSU.CV.005	90÷305V / 47/63 Hz	1 A	24Vdc	25	IP67
PSU.CV.006	90÷305V / 47/63 Hz	2,5 A	24Vdc	60	IP67
PSU.CV.007	90÷305V / 47/63 Hz	3,75 A	24Vdc	90	IP67
PSU.CV.021	90÷305V / 47/63 Hz	10 A	24Vdc	240	IP67

Control Gear

Code	Input	I Out	V Out	Watt	IP
CGE.004 - 0/1-10V	24Vdc	6,5 A	24Vdc	156	IP20
CGE.017 - DALI	24Vdc	6,5 A	24Vdc	156	IP20
CGE.017.IP - DALI	24Vdc	6,5 A	24Vdc	156	IP67
CGE.020 - DMX	24Vdc	6,5 A	24Vdc	156	IP20

Control Gear RGBW

Code	Input	I Out	V Out	Watt	IP
CGE.005 - DMX	24Vdc	4x700 mA	24Vdc	67,2	IP20

OPTICS

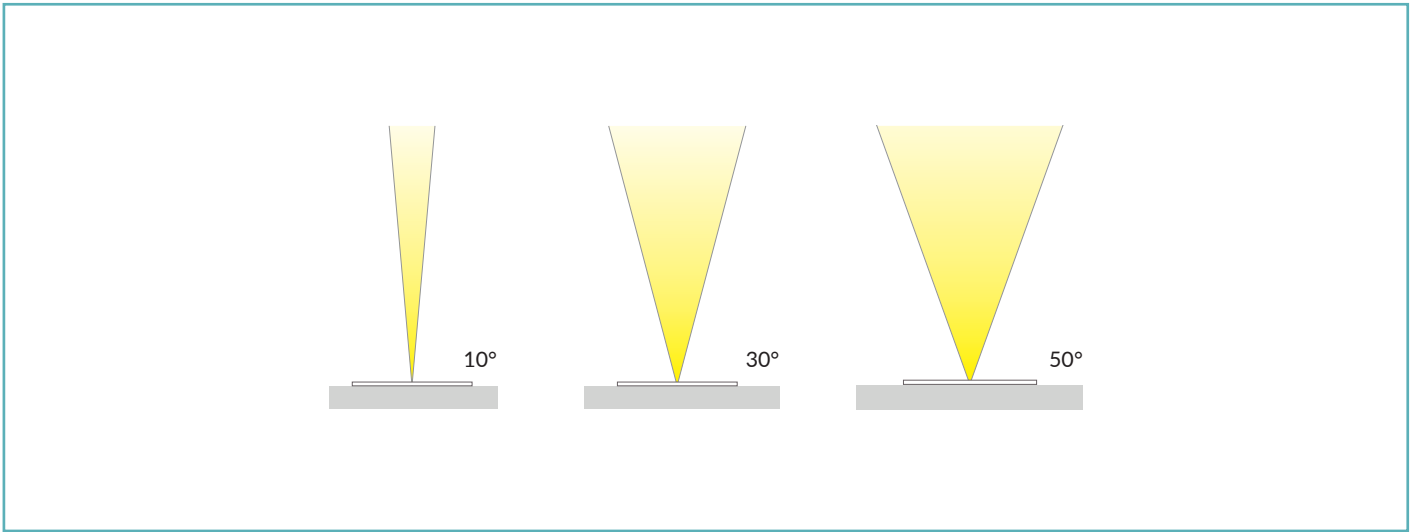

PHOTOMETRICS

