



# CALIBER 80 HV

TECHNICAL DATASHEET

## PROJECT INFORMATION

Project Name:

Reference:

Quantity:



MADE IN ITALY

## TECHNICAL DRAWING

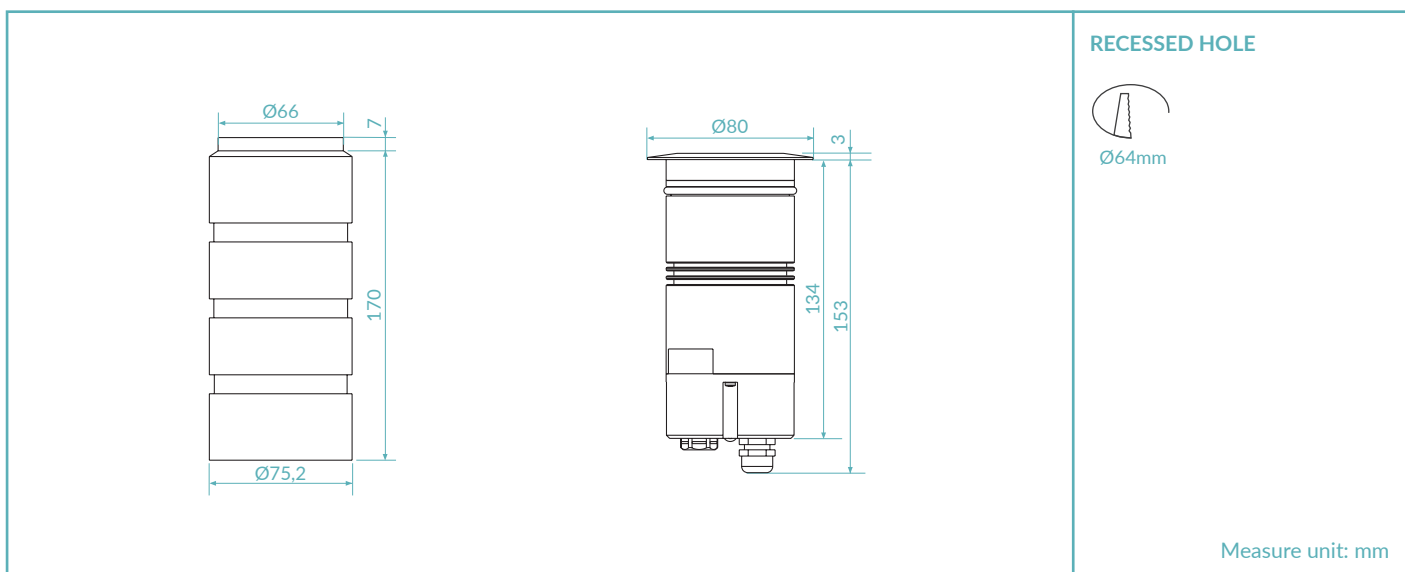

## FINISHES



## PRODUCT CODE

<b>C8H = CALIBER 80 HV</b> 	Select one component from each column to specify a complete configuration:		
	LED colour	Optics	Finish
27 = 2700K 30 = 3000K 40 = 4000K	N = 10° M = 30° W = 50° E = 10°x45° S = Satin	03 = Stainless steel AISI316L 10 = Aged solid brass 21 = Pre-aged solid brass	06 = 6W

Standard configuration example:

**C8H.30.N.03.06** | Caliber 80 HV 3000K 10° optics stainless steel 6W

## TECHNICAL SHEET

### LIGHTING CHARACTERISTICS

Color Rendering Index	CRI > 90
Lumen output (source)	540 lm (3000K)
Lumen output (delivered)	436 lm (3000K)
Optics	10° / 30° / 50° / 10°x 45° / Satin
LED colour temperature	2700K / 3000K / 4000K
LED lifetime	50000h L95 B10 (Ta 25°C)
Bin selection	Binning free 2 step MacAdam's

### MECHANICAL CHARACTERISTICS

Body	Stainless Steel AISI316L - Anodized aluminium 6026 / Solid brass - Anodized aluminium 6026
Glass	Tempered extra clear / frosted glass 6mm
Finishes	Stainless Steel AISI316L / Aged solid brass / Pre-aged solid brass
Installation	Housing box
Impact resistance	IK08
Weight	640g

### ELECTRICAL CHARACTERISTICS

Power supply	100-240 Vac 50/60Hz
Power supply cables	35cm H05RNF PCP 3x0,5mm <sup>2</sup>
Power consumption	6 Watt
Dimmable	On/Off only

### GENERAL CHARACTERISTICS

Operating temperature	-20°C +50°C
IP rating	IP67
Insulation class	Class I
Photobiological risk	RG0/RG1

ACCESSORIES

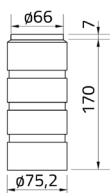

Housing box

Art. Nr.  
HB.006

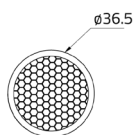

Honeycomb louver

Art. Nr.  
ACC.004

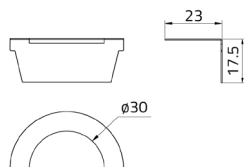

Anti-Glare louver

Art. Nr.  
ACC.073

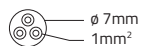

Cable

Art. Nr.  
CV00094  
CV00095

Length  
5m  
10m

OPTICS

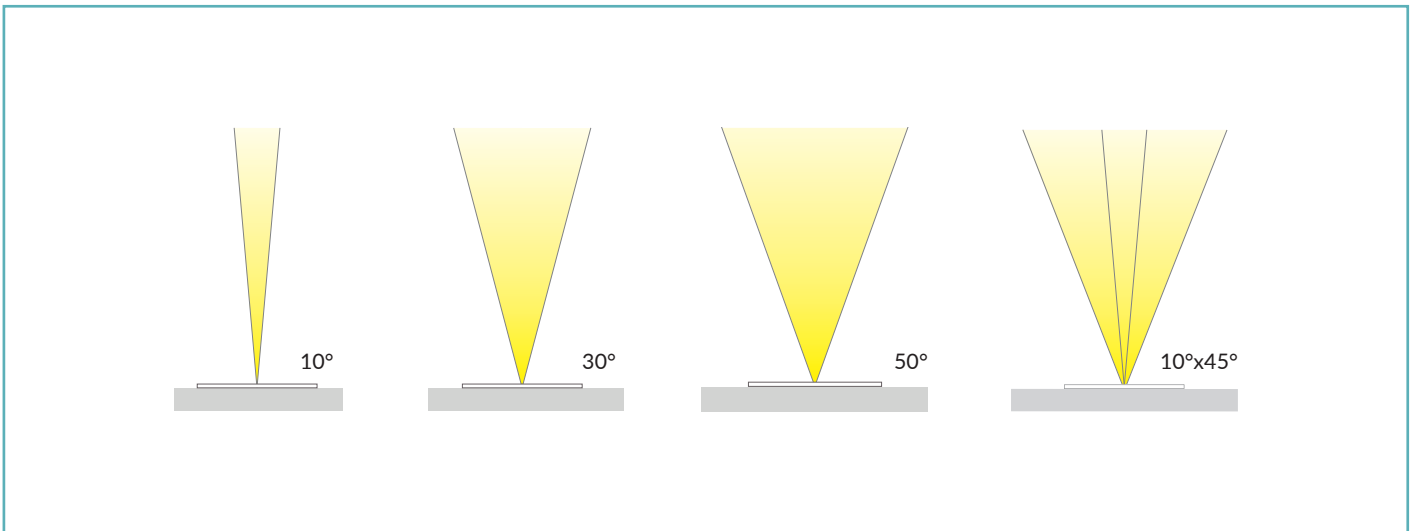

PHOTOMETRICS

