



# CALIBER 52

SCHEDA TECNICA

## INFORMAZIONI SUL PROGETTO

Nome progetto:

Riferimento:

Quantità:



IP68  
MADE IN ITALY

## DISEGNO TECNICO

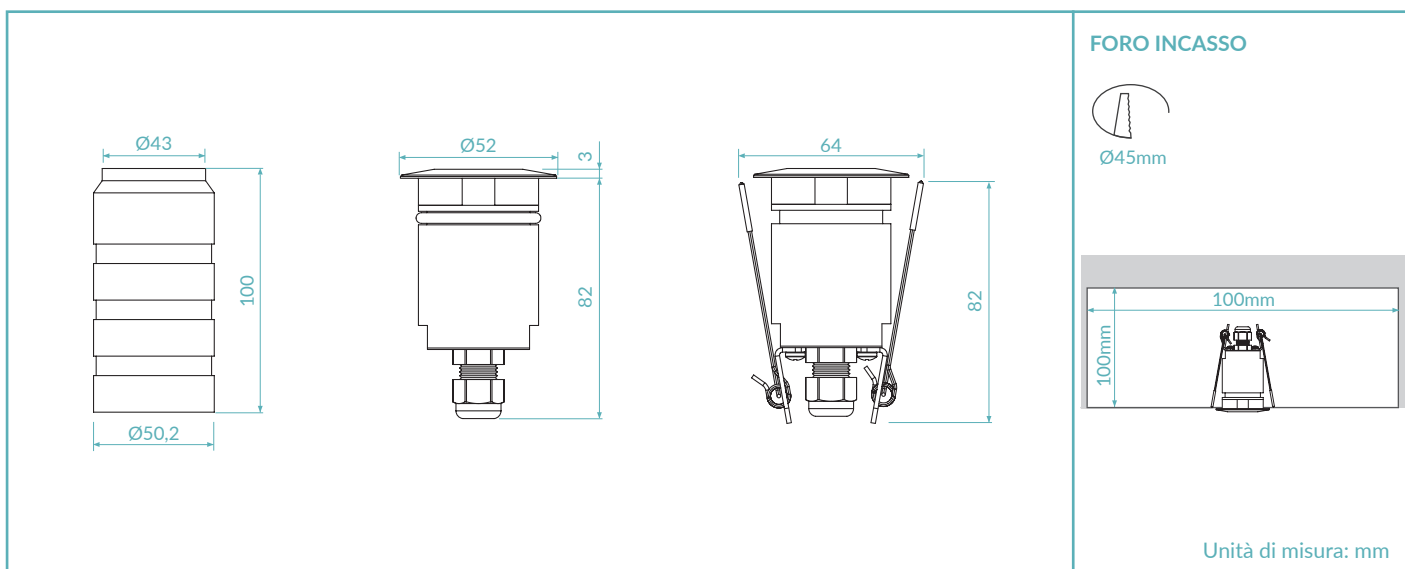

## FINITURE



## CODICE PRODOTTO

C52 = CALIBER 52

Selezionare un componente per ogni colonna per la configurazione completa:

	Colore LED	Ottiche	Finiture	Potenza
	22 = 2200K 27 = 2700K 30 = 3000K 40 = 4000K	N = 10° M = 23° W = 43° E = 10°x40° S = Satinato	03 = Acciaio INOX AISI316L 10 = Ottone anticato 21 = Ottone pre-anticato	02 = 2W

Esempio di configurazione standard:

C52.30.N.03.02 | Caliber 52 3000K 10° ottiche acciaio INOX 2 Watt

## SCHEDA PRODOTTO

## CARATTERISTICHE DI ILLUMINAZIONE

Indice resa cromatica	CRI > 90
Flusso sorgente	140 lm (3000K)
Flusso apparecchio	113 lm (3000K)
Ottiche	10° / 23° / 43° / 10°x40° / Satinato
Temperatura colore LED	2200K / 2700K / 3000K / 4000K
Vita media LED	50000h L95 B10 (Ta 25°C)
Selezione bin	Binning free 2 step MacAdam's

## CARATTERISTICHE MECCANICHE

Corpo	Acciaio INOX AISI316L - Alluminio 6026 anodizzato / Ottone - Alluminio 6026
Vetro	Vetro temprato extra chiaro / satinato 4mm
Finiture	Acciaio INOX AISI316L / Ottone anticato / Ottone pre-anticato
Fissaggio	Cassaforma / Molle di fissaggio
Protezione impatto	IK08
Peso	280g

## CARATTERISTICHE ELETTRICHE

Alimentazione	Tensione costante 24Vdc
Cavo di alimentazione	35cm NS20N PCP 2x0,5mm <sup>2</sup>
Power consumption	2 Watt
Dimmerazione	Dimmerabile

## CARATTERISTICHE GENERALI

Temperatura di funzionamento	-20°C +50°C
Grado di protezione	IP68 (no per immersione permanente)
Classe d'isolamento	Classe III
Rischio fotobiologico	RG0/RG1

ACCESSORI

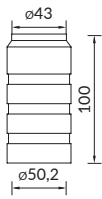

Cassaforma

Art. Nr.  
HB.002

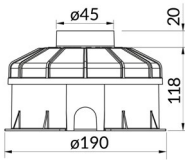

Cassaforma IP

Art. Nr.  
HB.013

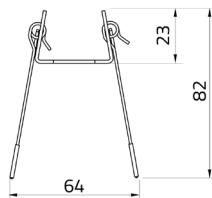

Molle di fissaggio

Art. Nr.  
ACC.006

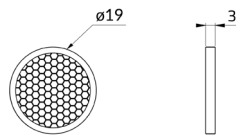

Schermo alveolare

Art. Nr.  
ACC.084

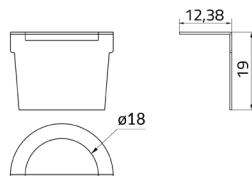

Frangiluce

Art. Nr.  
ACC.008

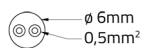

Cavi

Art. Nr.  
CV00037  
CV00040  
CV00041  
CV00042  
CV00043

Lunghezza

5m  
10m  
15m  
20m  
25m

## ALIMENTATORE TENSIONE COSTANTE 24Vdc

## On / Off

Codice	Input	I Out	V Out	Watt	IP
PSU.CX.004	110÷240V / 50/60 Hz	0,9 A	24Vdc	20	IP20
PSU.CV.005	90÷305V / 47/63 Hz	1 A	24Vdc	25	IP67
PSU.CV.006	90÷305V / 47/63 Hz	2,5 A	24Vdc	60	IP67
PSU.CV.007	90÷305V / 47/63 Hz	3,75 A	24Vdc	90	IP67
PSU.CV.021	90÷305V / 47/63 Hz	10 A	24Vdc	240	IP67

## Elettronica di controllo

Codice	Input	I Out	V Out	Watt	IP
CGE.004 - 0/1-10V	24Vdc	10 A	24Vdc	240	IP20
CGE.017 - DALI	24Vdc	10 A	24Vdc	240	IP20
CGE.017.IP - DALI	24Vdc	10 A	24Vdc	240	IP67
CGE.020 - DMX	24Vdc	6,5 A	24Vdc	156	IP20

OTTICHE

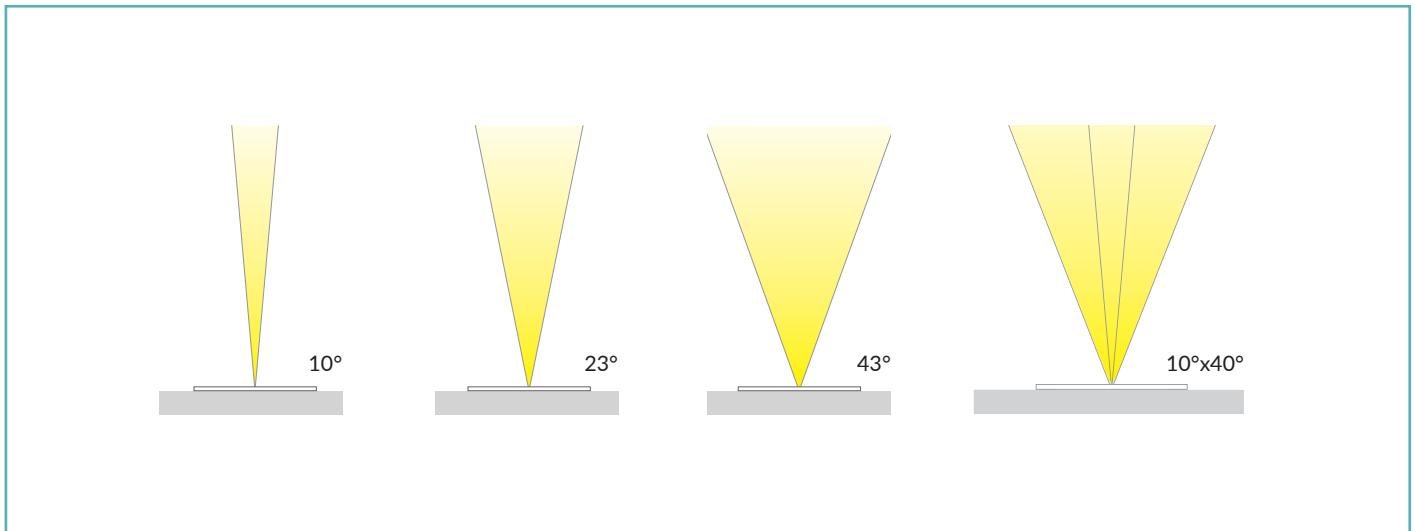

CURVE FOTOMETRICHE

