



CALIBER 52

FICHE TECHNIQUE

INFORMATIONS SUR LE PROJET

Nom du projet:

Référence:

Quantité:



IP68
MADE IN ITALY

DESSIN TECHNIQUE

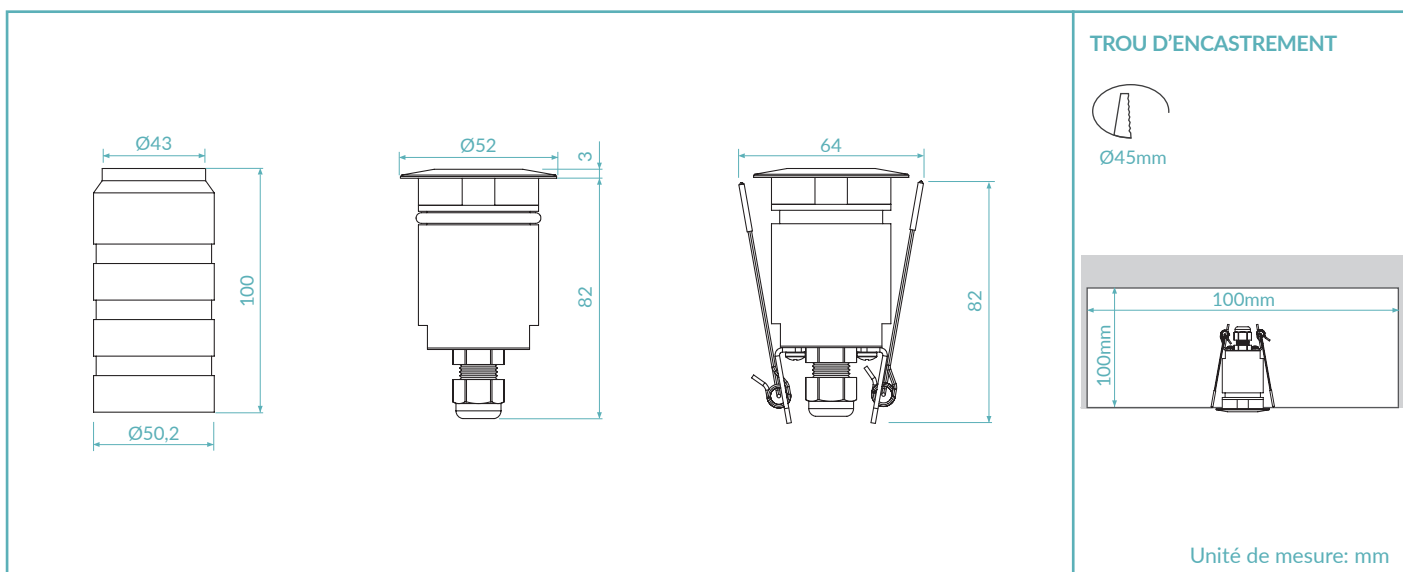

FINITIONS



CODE PRODUIT

C52 = CALIBER 52

Sélectionner un composant pour chaque colonne pour une configuration complète:

	Couleur LED	Optiques	Finitions	Puissance
	22 = 2200K 27 = 2700K 30 = 3000K 40 = 4000K	N = 10° M = 23° W = 43° E = 10°x40° S = Satiné	03 = Acier INOX AISI316L 10 = Laiton vieilli 21 = Laiton pre-vieilli	02 = 2W

Exemple de configuration standard:

C52.30.N.03.02 | Caliber 52 3000K 10° optiques acier INOX 2W

FICHE PRODUIT

CARACTÉRISTIQUES D'ÉCLAIRAGE

Color Rendering Index	CRI > 90
Flux lumineux (source)	140 lm (3000K)
Flux lumineux (sortant)	113 lm (3000K)
Optiques	10° / 23° / 43° / 10°x40° / Satiné
Température de couleur LED	2200K / 2700K / 3000K / 4000K
Durée moyenne LED	50000h L95 B10 (Ta 25°C)
Sélection du bin	Binning free 2 step MacAdam's

CARACTÉRISTIQUES MÉCANIQUES

Corp	Acier INOX AISI316L - Alluminium 6026 anodisé / Laiton - Alluminium 6026 anodisé
Verre	Verre trempé extra clair / satiné 4mm
Finitions	Acier INOX AISI316L / Laiton vieilli / Laiton pre-vieilli
Installations	Boîtier d'encastrement / Ressorts de montage
Indice de résistance	IK08
Poids	280g

CARACTÉRISTIQUES ÉLECTRIQUES

Alimentation	Tension constante 24Vdc
Puissance absorbée	35cm NS20N PCP 2x0,5mm ²
Power consumption	2 Watt
Dimmable	Dimmable

CARACTÉRISTIQUES GÉNÉRALES

Temperature de fonctionnement	-20°C +50°C
Indice de protection	IP68 (pas en immersion permanente)
Classe d'isolation	Class III
Sécurité photobiologique	RG0/RG1

ACCESSOIRES

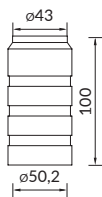

Boîtier d'encastrement **Art. Nr. HB.002**

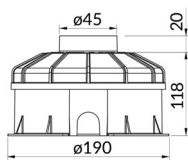

Boîtier d'encastrement IP **Art. Nr. HB.013**

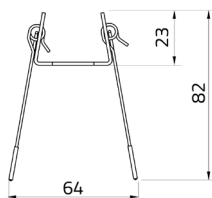

Ressorts de montage **Art. Nr. ACC.006**

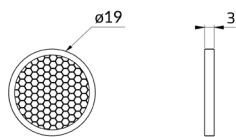

Grille nid d'abeille **Art. Nr. ACC.084**

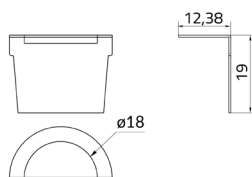
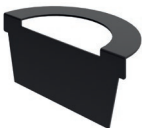

Visière anti-éblouissement **Art. Nr. ACC.008**

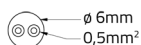

Câble	Art. Nr.	Longueur
	CV00037	5m
	CV00040	10m
	CV00041	15m
	CV00042	20m
CV00043	25m	

ALIMENTATEUR TENSION CONSTANTE 24Vdc

On / Off

Code	Input	I Out	V Out	Watt	IP
PSU.CX.004	110÷240V / 50/60 Hz	0,9 A	24Vdc	20	IP20
PSU.CV.005	90÷305V / 47/63 Hz	1 A	24Vdc	25	IP67
PSU.CV.006	90÷305V / 47/63 Hz	2,5 A	24Vdc	60	IP67
PSU.CV.007	90÷305V / 47/63 Hz	3,75 A	24Vdc	90	IP67
PSU.CV.021	90÷305V / 47/63 Hz	10 A	24Vdc	240	IP67

Control Gear

Code	Input	I Out	V Out	Watt	IP
CGE.004 - 0/1-10V	24Vdc	10 A	24Vdc	240	IP20
CGE.017 - DALI	24Vdc	10 A	24Vdc	240	IP20
CGE.017.IP - DALI	24Vdc	10 A	24Vdc	240	IP67
CGE.020 - DMX	24Vdc	6,5 A	24Vdc	156	IP20

OPTIQUES

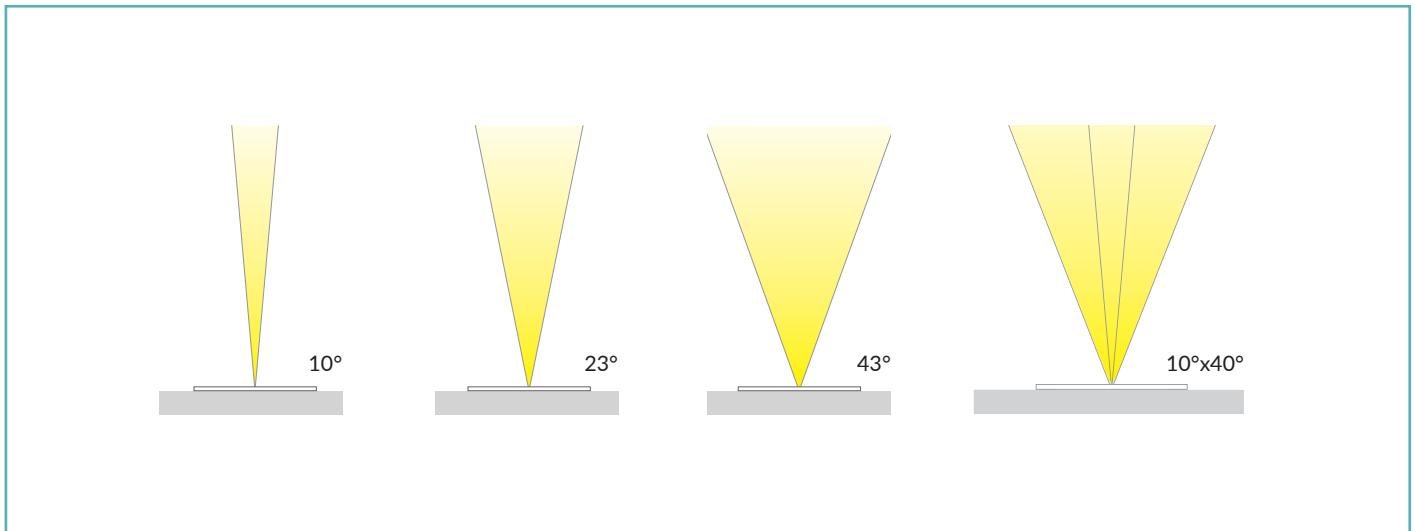

PHOTOMÉTRIE

