



CALIBER 52

TECHNICAL DATASHEET

PROJECT INFORMATION

Project Name:

Reference:

Quantity:



IP68
MADE IN ITALY

TECHNICAL DRAWING

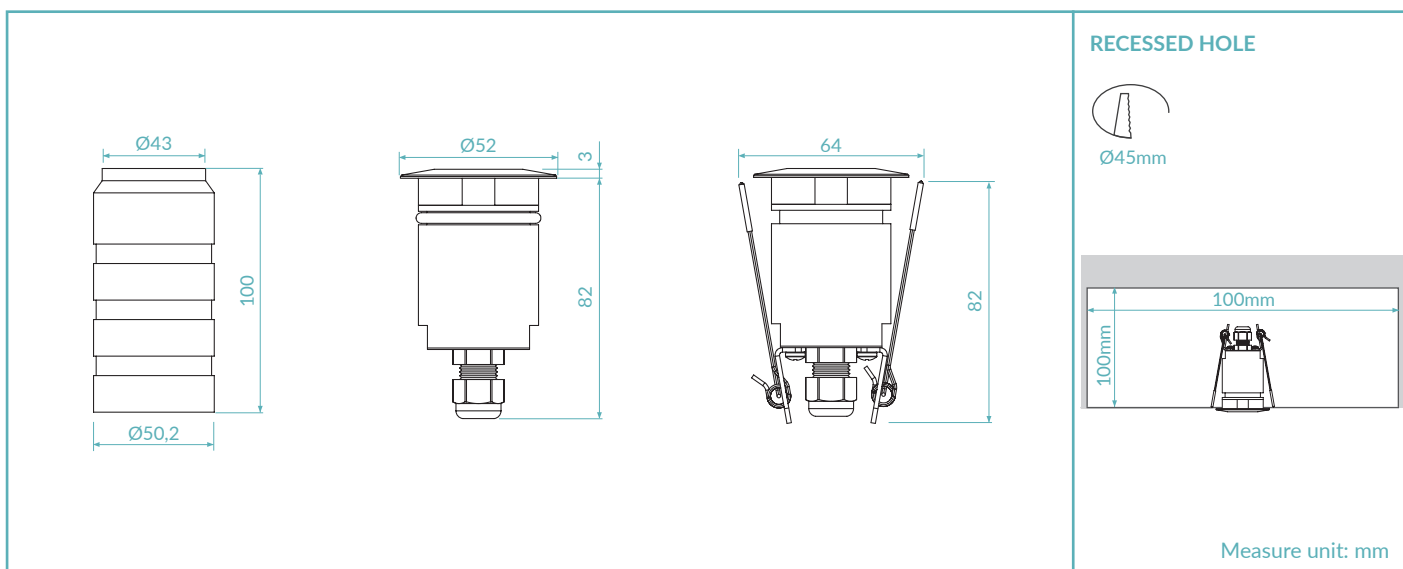

FINISHES



PRODUCT CODE

C52 = CALIBER 52	Select one component from each column to specify a complete configuration:			
	LED colour	Optics	Finish	Power
	22 = 2200K 27 = 2700K 30 = 3000K 40 = 4000K	N = 10° M = 23° W = 43° E = 10°x40° X = Satin	03 = Stainless steel AISI316L 10 = Aged solid brass 21 = Pre-aged solid brass	02 = 2W

Standard configuration example:

C52.30.N.03.02 | Caliber 52 3000K 10° optics stainless steel 2W

TECHNICAL SHEET

LIGHTING CHARACTERISTICS

Color Rendering Index	CRI > 90
Lumen output (source)	140 lm (3000K)
Lumen output (delivered)	113 lm (3000K)
Optics	10° / 23° / 43° / 10°x40° / Satin
LED colour temperature	2200K / 2700K / 3000K / 4000K
LED lifetime	50000h L95 B10 (Ta 25°C)
Bin selection	Binning free 2 step MacAdam's

MECHANICAL CHARACTERISTICS

Body	Stainless Steel AISI316L - Anodized aluminium 6026 / Solid brass - Anodized aluminium 6026
Glass	Tempered extra clear / frosted glass 4mm
Finishes	Stainless Steel AISI316L / Aged solid brass / Pre-aged solid brass
Installation	Housing box / Fixing Springs
Impact resistance	IK08
Weight	280g

ELECTRICAL CHARACTERISTICS

Power supply	Constant voltage 24Vdc
Power supply cables	35cm NS20N PCP 2x0,5mm ²
Power consumption	2 Watt
Dimmable	Dimmable

GENERAL CHARACTERISTICS

Operating temperature	-20°C +50°C
IP rating	IP68 (not for permanent immersions)
Insulation class	Class III
Photobiological risk	RG0/RG1

ACCESSORIES

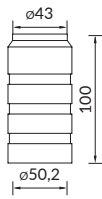

Housing box

Art. Nr.
HB.002

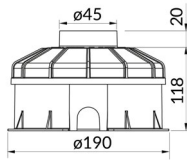

Housing box IP

Art. Nr.
HB.013

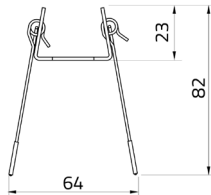

Fixing springs

Art. Nr.
ACC.006

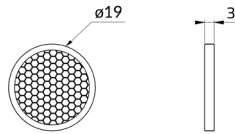

Honeycomb louver

Art. Nr.
ACC.084

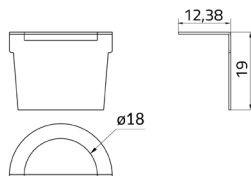

Anti-Glare louver

Art. Nr.
ACC.008

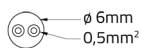

Cable

Art. Nr.
CV00037
CV00040
CV00041
CV00042
CV00043

Length
5m
10m
15m
20m
25m

POWER SUPPLIES 24Vdc CONSTANT VOLTAGE

On / Off

Code	Input	I Out	V Out	Watt	IP
PSU.CX.004	110÷240V / 50/60 Hz	0,9 A	24Vdc	20	IP20
PSU.CV.005	90÷305V / 47/63 Hz	1 A	24Vdc	25	IP67
PSU.CV.006	90÷305V / 47/63 Hz	2,5 A	24Vdc	60	IP67
PSU.CV.007	90÷305V / 47/63 Hz	3,75 A	24Vdc	90	IP67
PSU.CV.021	90÷305V / 47/63 Hz	10 A	24Vdc	240	IP67

Control Gear

Code	Input	I Out	V Out	Watt	IP
CGE.004 - 0/1-10V	24Vdc	6,5 A	24Vdc	156	IP20
CGE.017 - DALI	24Vdc	6,5 A	24Vdc	156	IP20
CGE.017.IP - DALI	24Vdc	6,5 A	24Vdc	156	IP67
CGE.020 - DMX	24Vdc	6,5 A	24Vdc	156	IP20

OPTICS

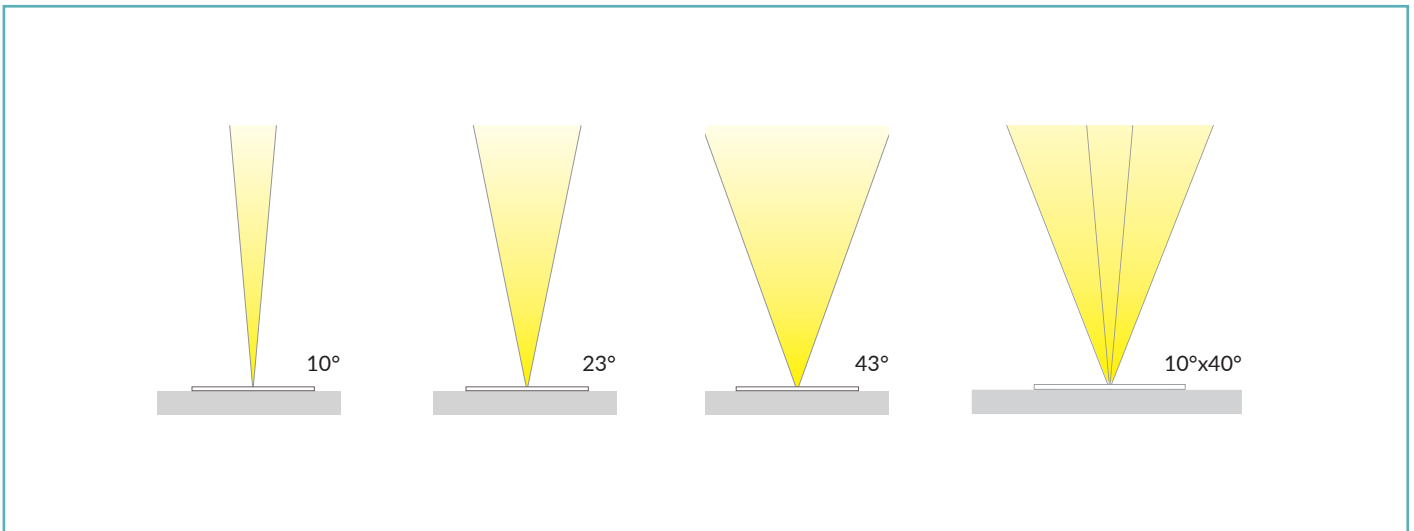

PHOTOMETRICS

