



IP20



## ZENDRA

Zendra is a professional square directional trimless LED luminaire, with a deep recessed COB LED light source and features high efficiency reflector technology for excellent glare control and uniformity. Zendra offers a choice of three colour temperatures as standard (2700K, 3000K and 4000K) and delivers 90 CRI for excellent colour rendering. With binning-free LEDs carefully selected from two-step MacAdam's ellipses, colour consistency is assured throughout the unonovesette portfolio.

*Zendra est un projecteur encastré à LED professionnel, avec une position en retrait de la source de lumière à LED COB. Grâce à la technologie des réflecteurs, il offre une excellente uniformité et un contrôle de l'éblouissement, offrant une rotation verticale de  $\pm 24^\circ$ . Zendra offre un choix de trois températures de couleur standard (2700K, 3000K et 4000K), 90 IRC pour un excellent rendu des couleurs. Binning-free et 2 step MacAdam garantissent la cohérence des couleurs dans toutes les versions fournies par unonovesette.*

### TECHNICAL DATA / FICHE TECHNIQUE:

IP20

Up to 12,9W @ 500mA  
Up to 11,8W (Dim to Warm)

1154 lm (3000K)  
1045 lm - 28 lm (DTW)

>90



2700K / 3000K / 4000K  
Dim to warm (3000K - 1800K)

20° / 32° / 40° / (20° / 40° DTW)

### FINISHES / FINITIONS:

White RAL 9003  
Blanc RAL 9003

Black RAL 9005  
Noir RAL 9005

### OPTICS / FAISCEAU:

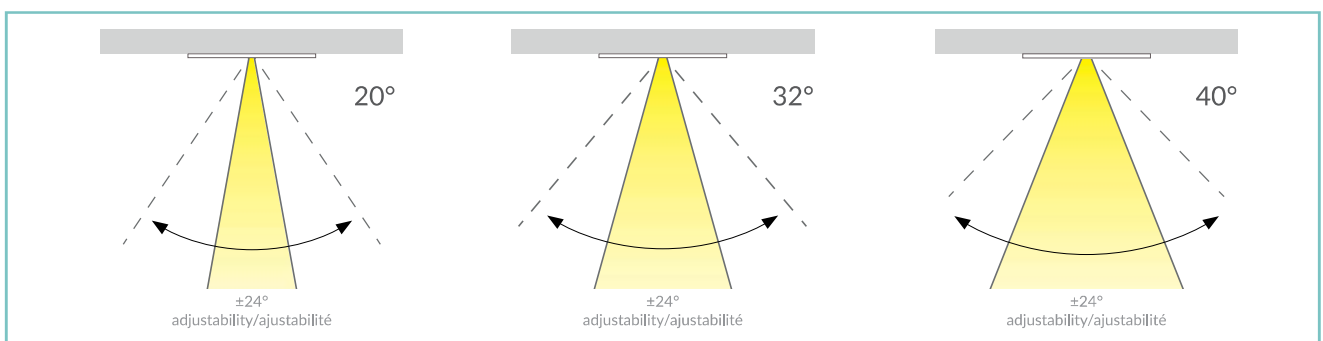



# unonovesette

## PRODUCT CODE/CODE PRODUIT:

ZEN = ZENDRA	Select one component from each column to specify a complete configuration: <i>Sélectionner un composant pour chaque colonne pour une configuration complète:</i>		
	LED colour / Couleur LED	Optics / Faisceau	Finish / Finitions
	27 = 2700K 30 = 3000K 40 = 4000K DW = Dim to warm	N = 20° (20° DTW) M = 32° W = 40° (40° DTW)	01 = White RAL 9003 / Blanc RAL 9003 02 = Black RAL 9005 / Noir RAL 9005

Standard configuration example/  
*Exemple de configuration standard:*

**ZEN.30.N.01** Zendra 3000K 20° optics white / blanc

## POWER SUPPLIES 500mA CONSTANT CURRENT / ALIMENTATEUR COURANT CONSTANT 500 mA:



### On / Off

Code / Code	Input	I Out	V Out	Watt	IP	#Zendra
PSU.CX.003	110+240V / 50/60 Hz	500mA	47 V	24	IP20	Max 1
PSU.CX.004	110+240V / 50/60 Hz	500mA	43 V	20	IP20	Max 1

### Dimmable / Gradable

Code / Code	Input	I Out	V Out	Watt	IP	#Zendra
PSU.CX.001 1-10V/PUSH	100+240V / 50/60 Hz	500mA	47 V	15	IP20	Max 1
PSU.CX.011 DALI	220+240V / 47/53 Hz	500mA	40 V	20	IP20	Max 1
PSU.CC.022 DTW / DALI	220+240V / 47/53 Hz	350mA	40 V	20	IP20	Max 1

## ACCESSORIES / ACCESSOIRES

	
Honeycomb louver <i>Grille nid d'abeille</i> ACC.001	Micro prismatic diffuser <i>Diffuseur micro prismatique</i> ACC.002

TECHNICAL DRAWING / DESSIN TECHNIQUE:

RECESSED HOLE / TROU D'ENCASTREMENT:

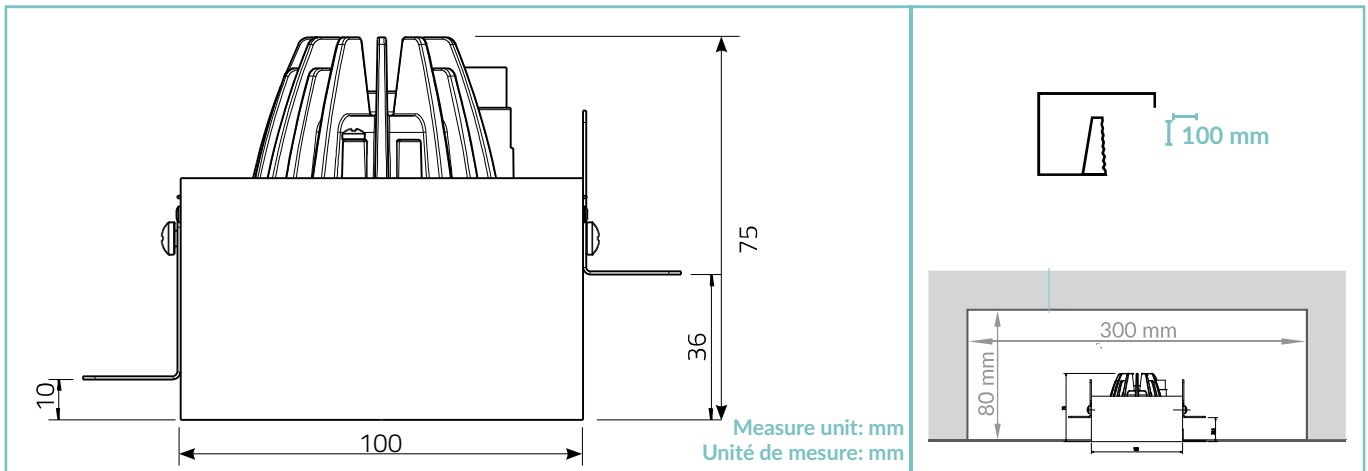

TECHNICAL SHEET / FICHE PRODUIT:

**Body:** Die-cast aluminium  
**Finishes:** White RAL 9003 / Black RAL 9005  
**Installation:** Housing box  
**Power supply cables:** 30 cm PVC + PVC 2x0,5 mm<sup>2</sup>  
**Power supply:** Constant current 500mA Max / (350mA-14mA Dim to warm)  
**Power consumption:** 12,9 Watt Max  
**CRI:** >90  
**Bin selection:** Binning free 2 step MacAdam's  
**Lumenoutput (source):** 1154 lm (3000K) / 1045 lm - 28 lm (DTW)  
**Operating temperature:** -20°C +50°C  
**IP rating:** IP20  
**Insulation class:** Class III  
**Weight:** 610 g  
**Optics:** 20° / 32° / 40° / (20° / 40° DTW)  
**LED colour temperature:** 2700K / 3000K / 4000K / (3000K-1800K DTW)  
**Lifetime LED:** 100000 hrs  
**Photo biological risk:** RG0 / RG1

**Corps:** Aluminium moulé sous pression  
**Finitions:** Blanc RAL 9003 / Noir RAL 9005  
**Installation:** Boîtier d'encastrement  
**Câbles d'alimentation:** 30 cm PVC + PVC 2x0,5 mm<sup>2</sup>  
**Alimentation:** Courant constant 500mA Max / (350mA-14mA Dim to warm)  
**Puissance absorbée:** 12,9 Watt Max  
**IRC Indice de Rendu des Couleurs:** >90  
**Sélection du bin:** Binning free 2 step MacAdam's  
**Flux de la source:** 1154 lm (3000K) / 1045 lm - 28 lm (DTW)  
**Température de fonctionnement:** -20°C +50°C  
**Indice de protection:** IP20  
**Classe d'isolation:** Classe III  
**Poids:** 610 g  
**Optiques:** 20° / 32° / 40° / (20° / 40° DTW)  
**Couleur LED:** 2700K / 3000K / 4000K / (3000K-1800K DTW)  
**Durée moyenne LED:** 100000 hrs  
**Sécurité photobiologique:** RG0 / RG1

PHOTOMETRICS / COURVES PHOTOMETRIQUE:

20° - 12,9 Watt

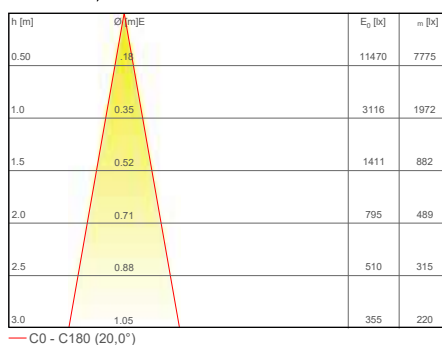

32° - 12,9 Watt

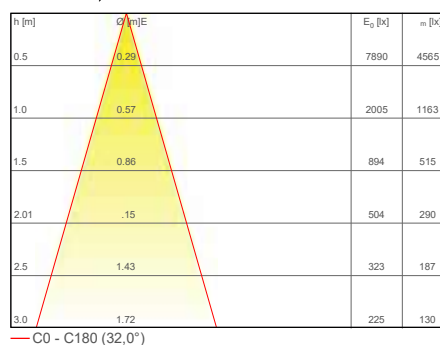

40° - 12,9 Watt

