











IP66

VARIO 60

Vario 60 is an extremely efficient compact LED projector, designed for optical excellence and engineered for complete resilience. Vario 60 offers a choice of three colour temperatures as standard (2700K, 3000K and 4000K) and delivers 90 CRI for excellent colour rendering, and with binning-free LEDs carefully selected from two-step MacAdam's ellipses, colour consistency is assured throughout the unonovesette portfolio. With a deep recess of the inhouse designed PCB, Vario 60 offers excellent glare control. Available with a choice of four beam angles (10°, 30°, 50° and elliptical).

Vario 60 è un apparecchio a LED dalle dimensioni compatte estremamente efficiente. Ideato con un'ottica eccellente e progettato per una completa flessibilità, Vario 60 offre una scelta fra tre temperature di colore standard (2700K, 3000K e 4000K) tutte con CRI maggiore di 90 per una eccellente resa cromatica. Binningfree e due-step MacAdam's ellipses LED, assicurano consistenza del colore in tutte le versioni previste da unonovesette. Con l'elettronica progettata internamente e ben posizionata, Vario 60 offre un eccellente controllo dell'abbagliamento. Disponibile con quattro diverse lenti (10°, 30°, 50° ed ellittica).

TECHNICAL DATA / DATI TECNICI:

 IP66	 2700K / 3000K / 4000K / RGBW / (3000K-1800K DTW)
 5W / 9W / 11W	 10° / 30° / 50° / 10°x45° / 45°x10° (20° / 40° DTW) / (35° RGBW)
 515 lm / 730 lm / 840 lm (3000K) 1045 lm-28 lm (DTW)	 CE
 A++	 Smart Shield
 CRI >90	

FINISHES / FINITURE:

	Natural anodized Anodizzato naturale
	Black anodized Nero anodizzato
	Machined aged solid brass Ottone anticato

OPTICS / OTTICHE:

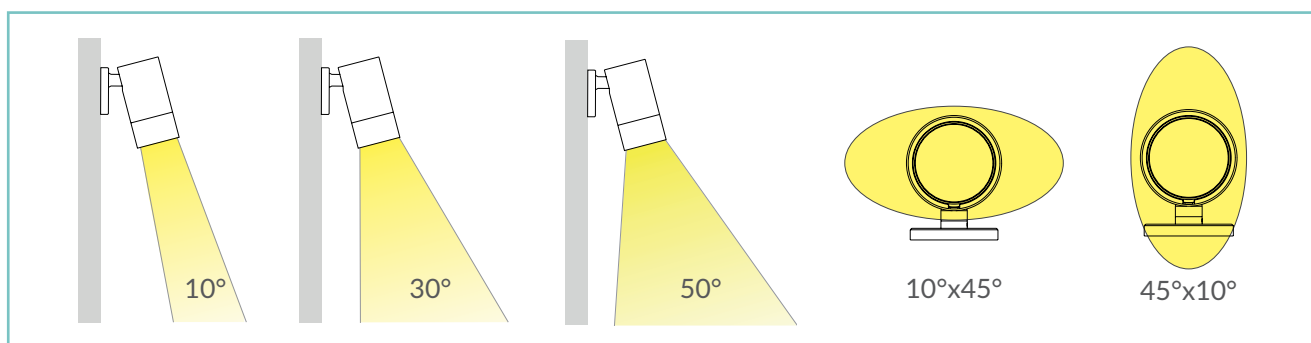



unonovesette

PRODUCT CODE / CODICE PRODOTTO:

V60 = VARIO 60		Select one component from each column to specify a complete configuration: Selezionare un componente per ogni colonna per la configurazione completa:			
		LED colour / Colore LED	Optics / Ottiche	Finish / Finiture	Watt
		27 = 2700K 30 = 3000K 40 = 4000K FC = RGBW DW = Dim to Warm	N = 10° M = 30° (20° DTW) (35° RGBW) W = 50° (40° DTW) E = 10°x45° X = 45°x10°	05 = Black anodized/ Anodizzato nero 07 = Natural anodized / Anodizzato naturale 10 = Aged brass / Ottone anticato	05 = 5 W 09 = 9 W 11 = 11 W

Standard configuration example/
Esempio di configurazione standard: **V60.30.N.07.09 Vario 60 3000K 10° optics natural anodized / anodizzato naturale 9 Watt**

POWER SUPPLIES 24Vdc CONSTANT VOLTAGE / ALIMENTATORE TENSIONE COSTANTE 24Vdc:







On / Off

Code / Code	Input	I Out	V Out	Watt	IP	#Vario 60
PSU.CX.004	110+240V / 50/60 Hz	0,9 A	24Vdc	20	IP20	Max 1
PSU.CV.005	90+305V / 47/63 Hz	1 A	24Vdc	25	IP67	Max 2
PSU.CV.006	90+305V / 47/63 Hz	2,5 A	24Vdc	60	IP67	Max 5
PSU.CV.007	90+305V / 47/63 Hz	3,75 A	24Vdc	90	IP67	Max 8
PSU.CC.022 DALI DIM TO WARM	220+240V / 47/53 Hz	350 mA	40Vdc	20	IP20	Max 1

Control gear / Elettronica di controllo

Code / Code	Input	I Out	V Out	Watt	IP	#Vario 60
CGE.004 - 0/1-10V	24Vdc	6,5 A	24Vdc	156	IP20	Max 14
CGE.017 - DALI	24Vdc	6,5 A	24Vdc	156	IP20	Max 14
CGE.017.IP - DALI	24Vdc	6,5 A	24Vdc	156	IP67	Max 14
CGE.020 - DMX	24Vdc	6,5 A	24Vdc	156	IP20	Max 14

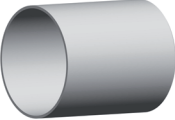
ACCESSORIES / ACCESSORI

 Honeycomb louver Schermo alveolare ACC.004	 Anti-Glare louver Frangiluce ACC.073	 Snoot 45° Paraluce 45° ACC.012	 Base Basetta ACC.076
 Ground spike Picchetto ACC.075	 Snoot tube Paraluce tubo ACC.107	 Tree strap Fascia per alberi ACC.082	 Cable Cavo CV00037 5m CV00040 10m CV00041 15m CV00042 20m CV00043 25m

TECHNICAL DRAWING / DISEGNO TECNICO:

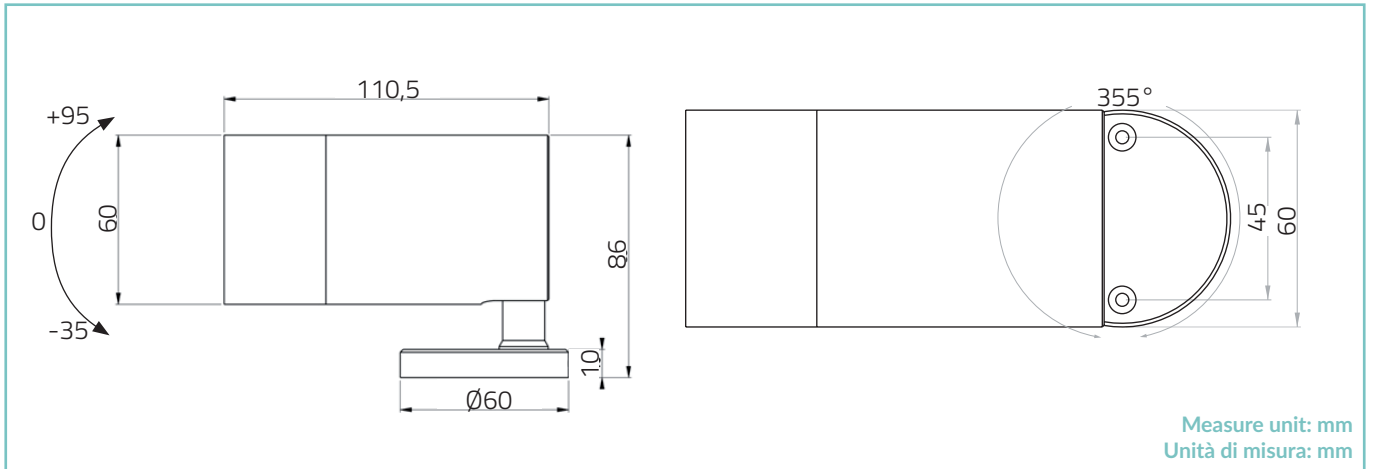

Measure unit: mm
Unità di misura: mm



TECHNICAL SHEET / SCHEDA PRODOTTO:

Body: Anodized aluminium 6026 / Machined aged brass
Glass: Extra clear tempered glass 5 mm
Finishes: Natural anodized / Black anodized / Aged solid brass
Installation: Surface mounted / Spike / Tree strap
Power supply cables: 100 cm NS20N PCP 2x0,5 mm²
Power supply: Constant voltage 24Vdc / 350-14 mA DTW
Power consumption: 5 Watt / 9 Watt / 11 Watt
CRI: >90
Bin selection: Binning free 2 step MacAdam's
Lumenoutput (source): 515 lm / 730 lm / 840 lm (3000K) / 1045 lm-28 lm (DTW)
Operating temperature: -20°C +50°C
IP rating: IP66
Insulation class: Class III
Impact resistance: IK08
Weight: 500 g
Optics: 10° / 30° / 50° / 10°x 45° / 45°x10° (20° / 40° DTW) / (35° RGBW)
Energy rating: A++
LED colour temperature: 2700K / 3000K / 4000K / RGBW / (3000K-1800K DTW)
Lifetime LED: 100000 hrs
Photo biological risk: RG0 / RG1

Corpo: Alluminio anodizzato 6026 / Ottone anticato tornito
Vetro: Vetro temperato extra chiaro 5 mm
Finiture: Anodizzato naturale / Anodizzato nero / Ottone anticato
Fissaggio: Su superficie / Picchetto / Cintura per albero
Cavo di alimentazione: 100 cm NS20N PCP 2x0,5 mm²
Alimentazione: Tensione costante 24vdc / 350-14 mA DTW
Potenza assorbita: 5 Watt / 9 Watt / 11 Watt
CRI: >90
Selezione bin: Binning free 2 step MacAdam's
Flusso luminoso (sorgente): 515 lm / 730 lm / 840 lm (3000K) / 1045 lm-28 lm (DTW)
Temperatura di funzionamento: -20°C +50°C
Grado di protezione: IP66
Classe d'isolamento: Classe III
Protezione impatto: IK08
Peso: 500 g
Ottiche: 10° / 30° / 50° / 10°x 45° / 45°x10° (20° / 40° DTW) / (35° RGBW)
Energy rating: A++
Temperatura colore LED: 2700K / 3000K / 4000K / RGBW / (3000K-1800K DTW)
Vita media LED: 100000 hrs
Rischio fotobiologico: RG0 / RG1

PHOTOMETRICS/CURVE FOTOMETRICHE:
10° - 11 Watt

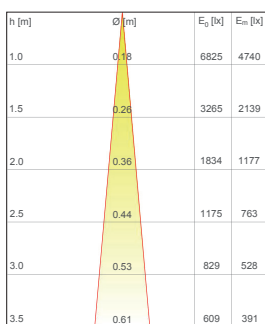

— C0 - C180 (10,0°)

30° - 11 Watt

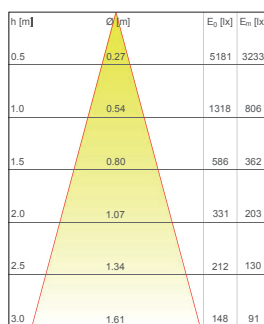

— C0 - C180 (30,0°)

50° - 11 Watt

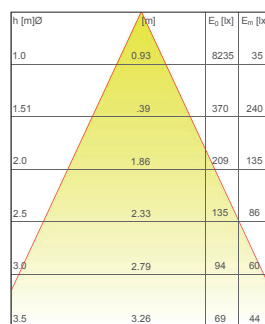

— C0 - C180 (50,0°)

10°x45° - 11 Watt

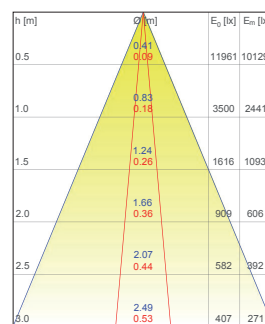

— C0 - C180 (10,0°)
— C90 - C270 (45 0°)

45°x10° - 11 Watt

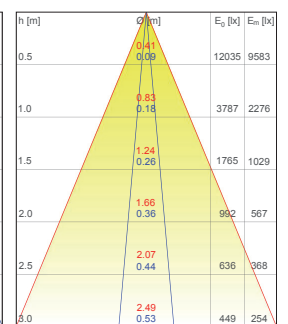

— C0 - C180 (45,0°)
— C90 - C270 (10,0°)