











IP66

## VARIO 60



Vario 60 is an extremely efficient compact LED projector, designed for optical excellence and engineered for complete resilience. Vario 60 offers a choice of three colour temperatures as standard (2700K, 3000K and 4000K) and delivers 90 CRI for excellent colour rendering, and with binning-free LEDs carefully selected from two-step MacAdam's ellipses, colour consistency is assured throughout the unonovesette portfolio. With a deep recess of the inhouse designed PCB, Vario 60 offers excellent glare control. Available with a choice of four beam angles (10°, 30°, 50° and elliptical).

*Vario 60 est un projecteur LED compact extrêmement efficace conçu avec d'excellentes optiques et pour une flexibilité totale. Vario 60 incorpore le système Smart Shield de unonovesette, ainsi qu'un driver en courant constant intégré qui permet au luminaire d'être alimenté en parallèle avec une alimentation à tension constante de 24 Vdc. Facilement dimmable avec les systèmes 24Vdc, DALI ou DMX. Une casquette asymétrique, une grille en nid d'abeille et une visière anti-éblouissement sont disponibles en option. Disponible avec quatre optiques (10°, 30°, 50° et elliptique).*

### TECHNICAL DATA / FICHE TECHNIQUE:

 IP66	 2700K / 3000K / 4000K / RGBW / (3000K-1800K DTW)
 5W / 9W / 11W	 10° / 30° / 50° / 10°x45° / 45°x10° (20° / 40° DTW) / (35° RGBW)
 515 lm / 730 lm / 840 lm (3000K) 1045 lm-28 lm (DTW)	 CE
 A++	 Smart Shield
 CRI >90	

### FINISHES / FINITIONS:

	Natural anodized Anodisé naturel
	Black anodized Anodisé noir
	Machined aged solid brass Laiton vieilli

### OPTICS / FAISCEAU:

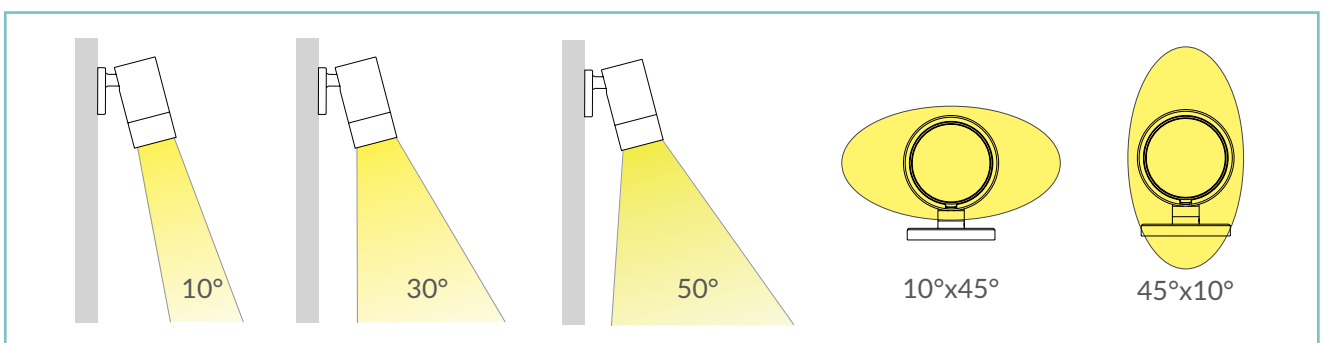



# unonovessette

## PRODUCT CODE/CODE PRODUIT:

V60 = VARIO 60		Select one component from each column to specify a complete configuration: Sélectionner un composant pour chaque colonne pour une configuration complète:			
		LED colour / Couleur LED	Optics / Faisceau	Finish / Finitions	Watt
		27 = 2700K 30 = 3000K 40 = 4000K FC = RGBW DW = Dim to Warm	N = 10° M = 30° (20° DTW) (35° RGBW) W = 50° (40° DTW) E = 10°x45° X = 45°x10°	05 = Black anodized / Anodisé Noir 07 = Natural anodized / Anodisé naturel 10 = Aged brass / Laiton vieilli	05 = 5 W 09 = 9 W 11 = 11 W

Standard configuration example/  
Exemple de configuration standard:

**V60.30.N.07.09 Vario 60 3000K 10° optics natural anodized / Anodisé naturel 9 Watt**

## POWER SUPPLIES 24Vdc CONSTANT VOLTAGE / ALIMENTATEUR TENSION CONSTANTE 24Vdc:







On / Off

Code / Code	Input	I Out	V Out	Watt	IP	#Vario 60
PSU.CX.004	110+240V / 50/60 Hz	0,9 A	24Vdc	20	IP20	Max 2
PSU.CV.005	90+305V / 47/63 Hz	1 A	24Vdc	25	IP67	Max 2
PSU.CV.006	90+305V / 47/63 Hz	2,5 A	24Vdc	60	IP67	Max 6
PSU.CV.007	90+305V / 47/63 Hz	3,75 A	24Vdc	90	IP67	Max 9
PSU.CC.022 DALI DIM TO WARM	220+240V / 47/53 Hz	350 mA	40Vdc	20	IP20	Max 1

Control gear / Système de control

Code / Code	Input	I Out	V Out	Watt	IP	#Vario 60
CGE.004 - 0/1-10V	24Vdc	6,5 A	24Vdc	156	IP20	Max 20
CGE.017 - DALI	24Vdc	6,5 A	24Vdc	156	IP20	Max 20
CGE.017.IP - DALI	24Vdc	6,5 A	24Vdc	156	IP67	Max 20
CGE.020 - DMX	24Vdc	6,5 A	24Vdc	156	IP20	Max 20

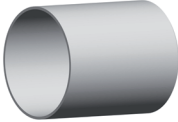
## ACCESSORIES / ACCESSOIRES

 Honeycomb louver Grille nid d'abeille ACC.004	 Anti-Glare louver Visière anti-éblouissement ACC.073	 Snoot 45° Casquette 45° ACC.012.10	 Base Base de fixation ACC.076
 Ground spike Piquet ACC.075.10	 Snoot tube Casquette tube ACC.107.10	 Tree strap Fixation aux arbres ACC.082	 Cable Câble CV00037 5m CV00040 10m CV00041 15m CV00042 20m CV00043 25m

**TECHNICAL DRAWING / DESSIN TECHNIQUE:**

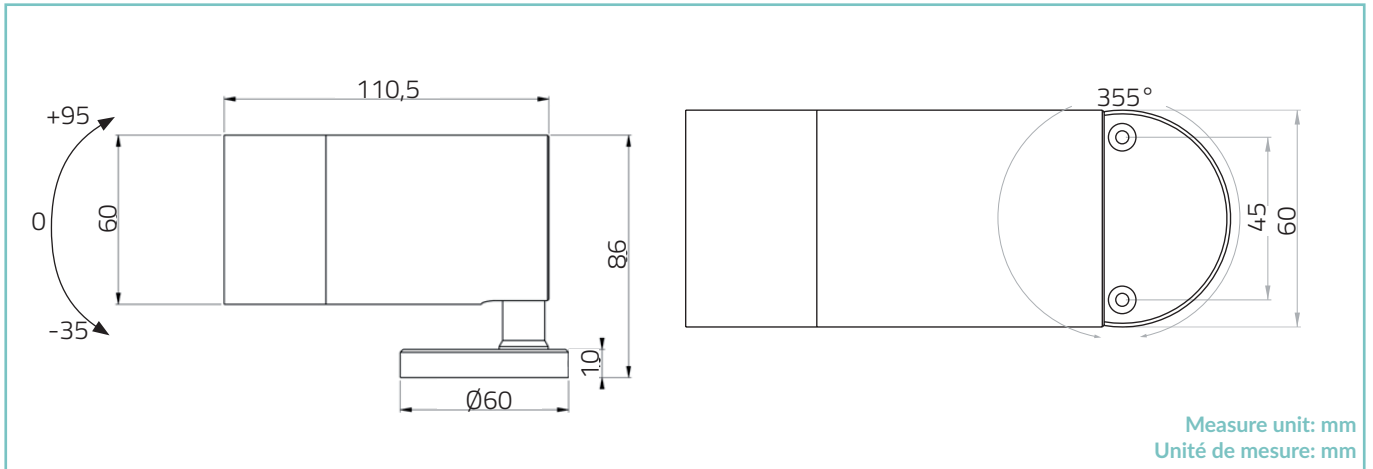

Measure unit: mm  
Unité de mesure: mm



**TECHNICAL SHEET / FICHE PRODUIT:**

**Body:** Anodized aluminium 6026 / Machined aged brass  
**Glass:** Extra clear tempered glass 5 mm  
**Finishes:** Natural anodized / Black anodized / Aged solid brass  
**Installation:** Surface mounted / Spike / Tree strap  
**Power supply cables:** 100 cm NS20N PCP 2x0,5 mm<sup>2</sup>  
**Power supply:** Constant voltage 24Vdc / 350-14 mA DTW  
**Power consumption:** 5 Watt / 9 Watt / 11 Watt  
**CRI:** >90  
**Bin selection:** Binning free 2 step MacAdam's  
**Lumenoutput (source):** 515 lm / 730 lm / 840 lm (3000K) / 1045 lm-28 lm (DTW)  
**Operating temperature:** -20°C +50°C  
**IP rating:** IP66  
**Insulation class:** Class III  
**Impact resistance:** IK08  
**Weight:** 500 g  
**Optics:** 10° / 30° / 50° / 10°x 45° / 45°x10° (20° / 40° DTW) / (35° RGBW)  
**Energy rating:** A++  
**LED colour temperature:** 2700K / 3000K / 4000K / RGBW / (3000K-1800K DTW)  
**Lifetime LED:** 100000 hrs  
**Photo biological risk:** RG0 / RG1

**Corps:** Anodisé naturel 6026 / Laiton vieilli tourné  
**Verre:** Verre temperé extra clair 5 mm  
**Finitions:** Anodisé naturel / Anodisé Noir / Laiton vieilli  
**Installation:** Surface / Piquet / Fixation aux arbres  
**Câbles d'alimentation:** 100 cm NS20N PCP 2x0,5 mm<sup>2</sup>  
**Alimentation:** Tension constante 24vdc / 350-14 mA DTW  
**Puissance absorbée:** 5 Watt / 9 Watt / 11 Watt  
**IRC Indice de Rendu des Couleurs:** >90  
**Sélection du bin:** Binning free 2 step MacAdam's  
**Flux de la source:** 515 lm / 730 lm / 840 lm (3000K) / 1045 lm-28 lm (DTW)  
**Température de fonctionnement:** -20°C +50°C  
**Indice de protection:** IP66  
**Classe d'isolation:** Classe III  
**Indice de résistance:** IK08  
**Poids:** 500 g  
**Optiques:** 10° / 30° / 50° / 10°x 45° / 45°x10° (20° / 40° DTW) / (35° RGBW)  
**Energy rating:** A++  
**Couleur LED:** 2700K / 3000K / 4000K / RGBW / (3000K-1800K DTW)  
**Durée moyenne LED:** 100000 hrs  
**Sécurité photobiologique:** RG0 / RG1

**PHOTOMETRICS/COURVES PHOTOMETRIQUE:**

