











IP66

VARIO 40

Vario 40 is an extremely efficient compact LED projector, designed for optical excellence and engineered for complete resilience. Vario 40 offers a choice of four colour temperatures as standard (2200K, 2700K, 3000K and 4000K) and delivers 90 CRI for excellent colour rendering, and with binning-free LEDs carefully selected from two-step MacAdam's ellipses, colour consistency is assured throughout the unonovesette portfolio. With a deep recess of the in-house designed PCB, Vario 40 offers excellent glare control.

Vario 40 è un apparecchio a LED dalle dimensioni compatte estremamente efficiente. Ideato con un'ottica eccellente e progettato per una completa flessibilità, Vario 40 offre una scelta fra quattro temperature di colore standard (2200K, 2700K, 3000K e 4000K) tutte con CRI maggiore di 90 per una eccellente resa cromatica. Binningfree e due-step MacAdam's ellipses LED, assicurano consistenza del colore in tutte le versioni previste da unonovesette. Con l'elettronica progettata internamente e ben posizionata, Vario 40 offre un eccellente controllo dell'abbagliamento.

TECHNICAL DATA / DATI TECNICI:

 IP66	 2200K / 2700K / 3000K / 4000K
 2,6 W / 3,6 W	 10° / 23° / 43° / 10°x40° / 40°x10°
 210 lm / 283 lm (3000K)	 CE
 A++	 Smart Shield
 CRI >90	

FINISHES / FINITURE:

	Natural anodized Anodizzato naturale
	Black anodized Nero anodizzato
	Machined aged solid brass Ottone anticato

OPTICS / OTTICHE:

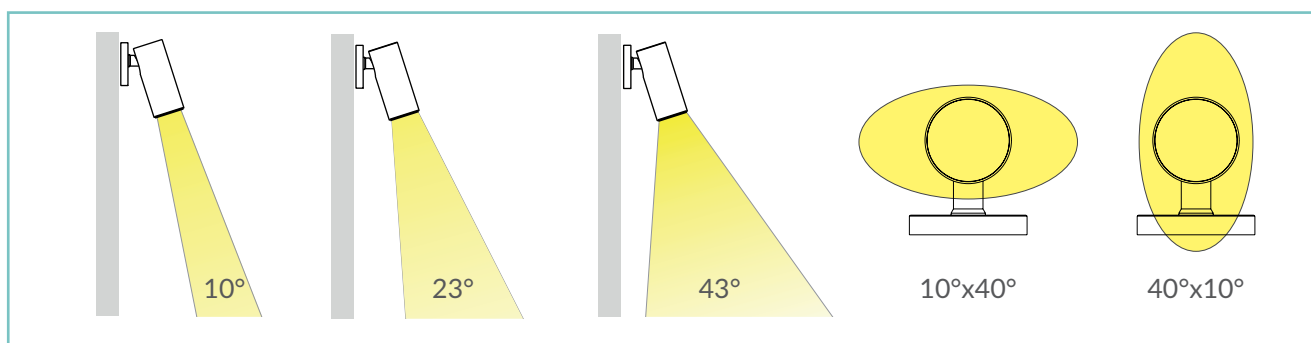



unonovesette

PRODUCT CODE / CODICE PRODOTTO:

V40 = VARIO 40		Select one component from each column to specify a complete configuration: Selezionare un componente per ogni colonna per la configurazione completa:			
		LED colour / Colore LED	Optics / Ottiche	Finish / Finiture	Watt
		22 = 2200K 27 = 2700K 30 = 3000K 40 = 4000K	N = 10° M = 23° W = 43° E = 10°x 40° X = 40°x10°	05 = Black anodized/ Anodizzato nero 07 = Natural anodized / Anodizzato naturale 10 = Aged brass / Ottone anticato	02 = 2,6 W 04 = 3,6 W

Standard configuration example/
Esempio di configurazione standard:

V40.30.N.07.04 Vario 40 3000K 10° optics natural anodized / anodizzato naturale 3,6 Watt

POWER SUPPLIES 24Vdc CONSTANT VOLTAGE / ALIMENTATORE TENSIONE COSTANTE 24Vdc:







On / Off

Code / Codice	Input	I Out	V Out	Watt	IP	#Vario 40
PSU.CX.004	110+240V / 50/60 Hz	0,9 A	24Vdc	20	IP20	Max 4
PSU.CV.005	90+305V / 47/63 Hz	1 A	24Vdc	25	IP67	Max 5
PSU.CV.006	90+305V / 47/63 Hz	2,5 A	24Vdc	60	IP67	Max 12
PSU.CV.007	90+305V / 47/63 Hz	3,75 A	24Vdc	90	IP67	Max 20

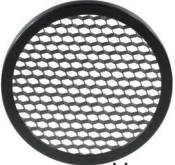
Control gear / Elettronica di controllo

Code / Codice	Input	I Out	V Out	Watt	IP	#Vario 40
CGE.004 - 0/1-10V	24Vdc	6,5 A	24Vdc	156	IP20	Max 40
CGE.017 - DALI	24Vdc	6,5 A	24Vdc	156	IP20	Max 40
CGE.017.IP - DALI	24Vdc	6,5 A	24Vdc	156	IP67	Max 40
CGE.020 - DMX	24Vdc	6,5 A	24Vdc	156	IP20	Max 40

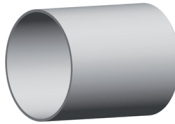
ACCESSORIES / ACCESSORI

 Honeycomb louver Schermo alveolare ACC.109	 Tree strap Fascia per alberi ACC.082	 Snoot 45° Paraluce 45° ACC.011	 Base Basetta ACC.076
 Ground spike Picchetto ACC.075	 Snoot tube Paraluce tubo ACC.106	CV00037 CV00040 CV00041 CV00042 CV00043	 Cable Cavo 5m 10m 15m 20m 25m

TECHNICAL DRAWING / DISEGNO TECNICO:

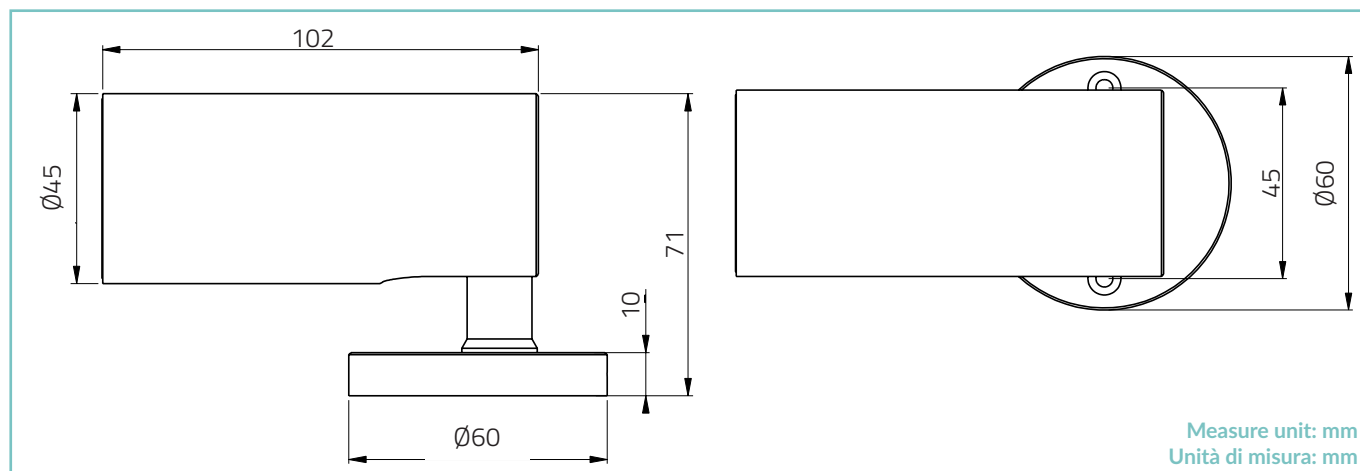

TECHNICAL SHEET / SCHEDA PRODOTTO:

Body: Anodized aluminium 6026 / Machined aged brass
Glass: Extra clear tempered glass 3 mm
Finishes: Natural anodized / Black anodized / Aged solid brass
Installation: Surface mounted / Spike / Tree strap
Power supply cables: 100 cm NS20N PCP 2x0,5 mm²
Power supply: Constant voltage 24Vdc
Power consumption: 2,6 Watt / 3,6 Watt
CRI: >90
Bin selection: Binning free 2 step MacAdam's
Lumen Output: (source) 210 lm / 283 lm (3000K)
Operating temperature: -20°C +50°C
IP rating: IP66
Insulation class: Class III
Impact resistance: IK07
Weight: 270 g
Optics: 10° / 23° / 43° / 10°x 40° / 40°x10°
Energy rating: A++
LED colour temperature: 2200K / 2700K / 3000K / 4000K
Lifetime LED: 100000 hrs
Photo biological risk: RG0 / RG1

Corpo: Alluminio anodizzato 6026 / Ottone anticato tornito
Vetro: Vetro temperato extra chiaro 3 mm
Finiture: Anodizzato naturale / Anodizzato nero / Ottone anticato
Fissaggio: Su superficie / Picchetto / Cintura per albero
Cavo di alimentazione: 100 cm NS20N PCP 2x0,5 mm²
Alimentazione: Tensione costante 24vdc
Potenza assorbita: 2,6 Watt / 3,6 Watt
CRI: >90
Selezione bin: Binning free 2 step MacAdam's
Flusso luminoso (sorgente): 210 lm / 283 lm (3000K)
Temperatura di funzionamento: -20°C +50°C
Grado di protezione: IP66
Classe d'isolamento: Classe III
Protezione impatto: IK07
Peso: 270 g
Ottiche: 10° / 23° / 43° / 10°x 40° / 40°x10°
Energy rating: A++
Temperatura colore LED: 2200K / 2700K / 3000K / 4000K
Vita media LED: 100000 hrs
Rischio fotobiologico: RG0 / RG1

PHOTOMETRICS / CURVE FOTOMETRICHE:

10° - 3,6 Watt

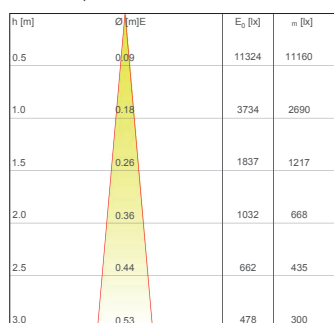

— C0 - C180 (10,0°)

23° - 3,6 Watt

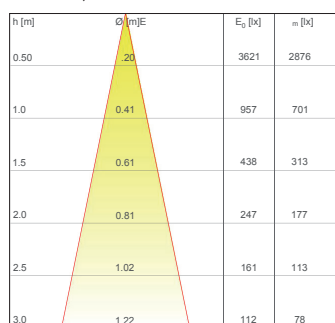

— C0 - C180 (23,0°)

43° - 3,6 Watt

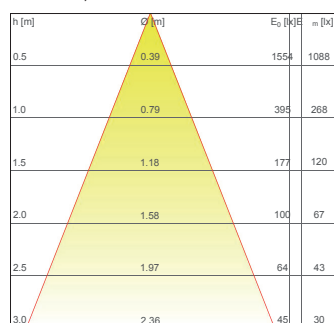

— C0 - C180 (43,0°)

40°x10° - 3,6 Watt

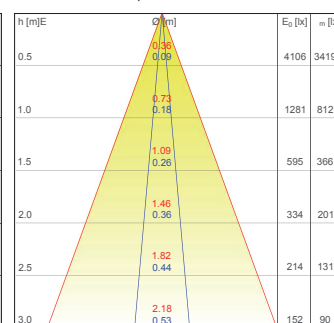

— C0 - C180 (45,0°) — C90 - C270 (10,0°)