











IP66

VARIO 40

Vario 40 is an extremely efficient compact LED projector, designed for optical excellence and engineered for complete resilience. Vario 40 offers a choice of four colour temperatures as standard (2200K, 2700K, 3000K and 4000K) and delivers 90 CRI for excellent colour rendering, and with binning-free LEDs carefully selected from two-step MacAdam's ellipses, colour consistency is assured throughout the unonovesette portfolio. With a deep recess of the in-house designed PCB, Vario 40 offers excellent glare control.

Vario 40 è un apparecchio a LED dalle dimensioni compatte estremamente efficiente. Ideato con un'ottica eccellente e progettato per una completa flessibilità, Vario 40 offre una scelta fra quattro temperature di colore standard (2200K, 2700K, 3000K e 4000K) tutte con CRI maggiore di 90 per una eccellente resa cromatica. Binningfree e due-step MacAdam's ellipses LED, assicurano consistenza del colore in tutte le versioni previste da unonovesette. Con l'elettronica progettata internamente e ben posizionata, Vario 40 offre un eccellente controllo dell'abbagliamento.

TECHNICAL DATA / DATI TECNICI:

 IP66	 2200K / 2700K / 3000K / 4000K
 2,6W / 3,6W	 10° / 23° / 43° / 10°x40° / 40°x10°
 188 lm / 263 lm (3000K)	 Smart Shield
 >90	
	

FINISHES / FINITURE:

	Natural anodized Anodizzato naturale
	Black anodized Nero anodizzato
	Aged solid brass Ottone anticato
	Pre-aged solid brass Ottone pre-anticato

OPTICS / OTTICHE:

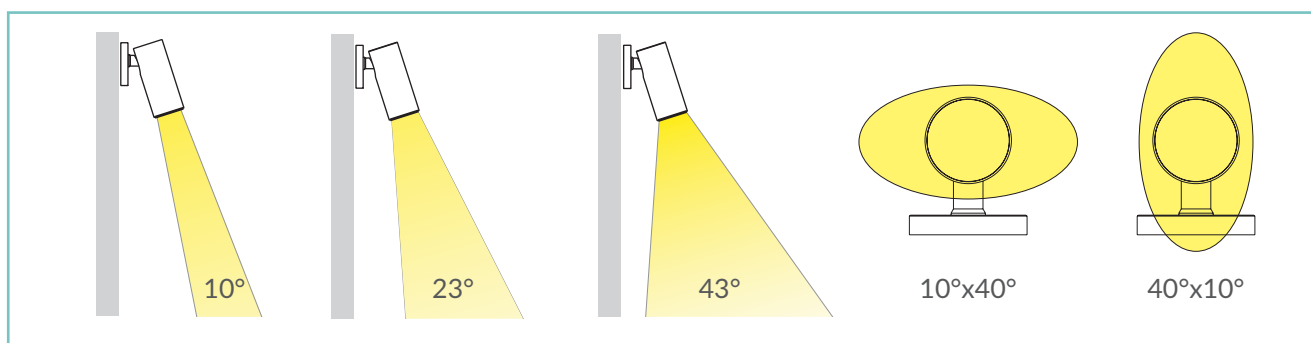

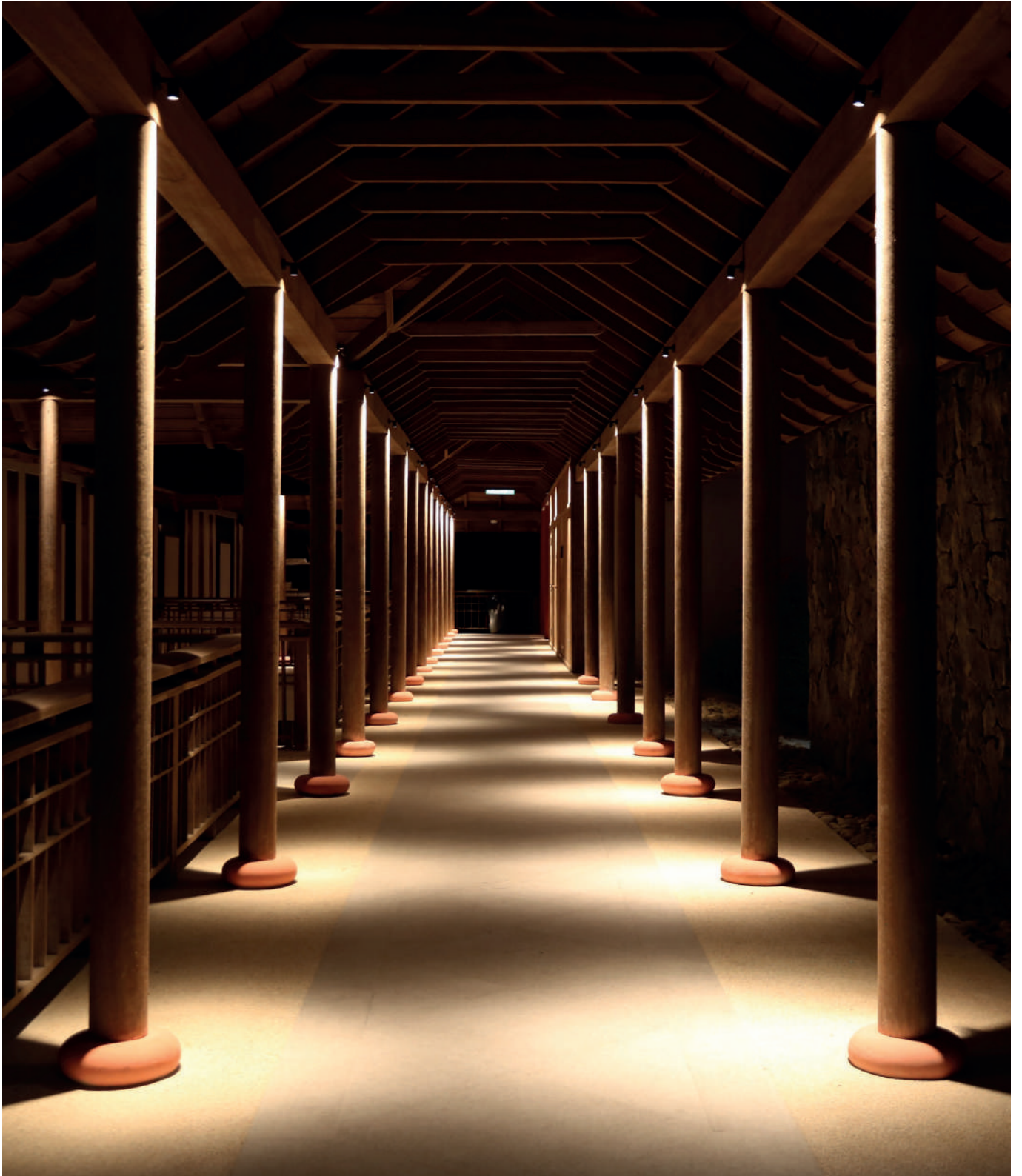

unonovesette

PRODUCT CODE / CODICE PRODOTTO:

V40 = VARIO 40		Select one component from each column to specify a complete configuration: Selezionare un componente per ogni colonna per la configurazione completa:			
		LED colour / Colore LED	Optics / Ottiche	Finish / Finiture	Power / Potenza
		22 = 2200K 27 = 2700K 30 = 3000K 40 = 4000K	N = 10° M = 23° W = 43° E = 10°x 40° X = 40°x10°	05 = Black anodized / Anodizzato nero 07 = Natural anodized / Anodizzato naturale 10 = Aged solid brass / Ottone anticato 21 = Pre-aged solid brass / Ottone pre-anticato	02 = 2,6W 04 = 3,6W

Standard configuration example/
Esempio di configurazione standard:

V40.30.N.07.04 Vario 40 3000K 10° optics natural anodized / Anodizzato naturale 3,6W

POWER SUPPLIES 24Vdc CONSTANT VOLTAGE / ALIMENTATORE TENSIONE COSTANTE 24Vdc:









On / Off 3,6W

Code / Codice	Input	I Out	V Out	Watt	IP	#Vario 40
PSU.CX.004	110+240V / 50/60 Hz	0,9 A	24Vdc	20	IP20	Max 4
PSU.CV.005	90+305V / 47/63 Hz	1 A	24Vdc	25	IP67	Max 5
PSU.CV.006	90+305V / 47/63 Hz	2,5 A	24Vdc	60	IP67	Max 12
PSU.CV.007	90+305V / 47/63 Hz	3,75 A	24Vdc	90	IP67	Max 20

Control gear / Elettronica di controllo 3,6W

Code / Codice	Input	I Out	V Out	Watt	IP	#Vario 40
CGE.004 - 0/1-10V	24Vdc	6,5 A	24Vdc	156	IP20	Max 35
CGE.017 - DALI	24Vdc	6,5 A	24Vdc	156	IP20	Max 35
CGE.017.IP - DALI	24Vdc	6,5 A	24Vdc	156	IP67	Max 35
CGE.020 - DMX	24Vdc	6,5 A	24Vdc	156	IP20	Max 35

ACCESSORIES / ACCESSORI

 Honeycomb louver Schermo alveolare ACC.109	 Snoot 45° Paraluce 45° ACC.011	 Snoot tube Paraluce tubo ACC.106	 Base Basetta ACC.076	 Base with side cable entrance Base con foro laterale ACC.162
 Tree strap Fascia per alberi ACC.082.01 1 base ACC.082.02 2 basi ACC.082.03 3 basi ACC.082.04 4 basi	 Extension bracket Braccio prolunga ACC.141.30 30cm	 Ground spike Picchetto ACC.075.035 35cm ACC.075.050 50cm ACC.075.100 100cm ACC.075.150 150cm	 Cable Cavo CV00037 5m CV00040 10m CV00041 15m CV00042 20m CV00043 25m	

TECHNICAL DRAWING / DISEGNO TECNICO:

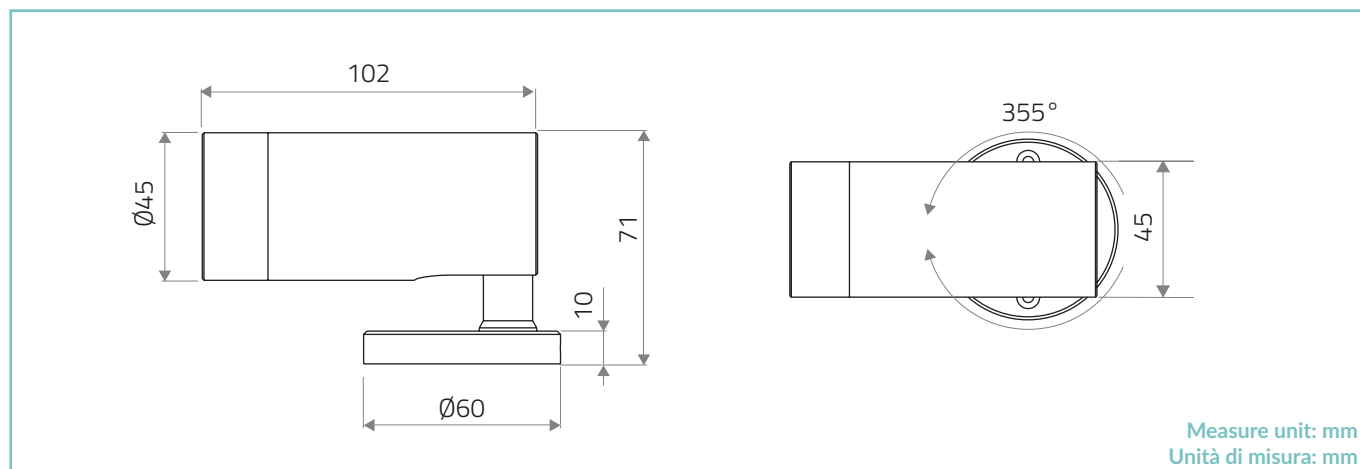

TECHNICAL SHEET / SCHEDA PRODOTTO:

Body: Anodized aluminium 6026 / Solid brass
Glass: Extra clear tempered glass 3mm
Finishes: Natural anodized / Black anodized / Aged solid brass / Pre-aged solid brass
Installation: Surface mounted / Spike / Tree strap
Power supply cables: 100cm NS20N PCP 2x0,5mm²
Power supply: Constant voltage 24Vdc
Power consumption: 2,6 Watt / 3,6 Watt
CRI: >90
Bin selection: Binning free 2 step MacAdam's
Lumen output (source): 188 lm / 263 lm (3000K)
Lumen output (delivered): 174 lm / 215 lm (3000K)
Operating temperature: -20°C +50°C
IP rating: IP66
Insulation class: Class III
Impact resistance: IK07
Weight: 270g alluminium / 990g brass
Optics: 10° / 23° / 43° / 10°x 40° / 40°x10°
LED colour temperature: 2200K / 2700K / 3000K / 4000K
Lifetime LED: 50000h L95 B10 (Ta 25°C)
Photo biological risk: RGO / RG1

Corpo: Alluminio anodizzato 6026 / Ottone tornito
Vetro: Vetro temprato extra chiaro 3mm
Finiture: Anodizzato naturale / Anodizzato nero / Ottone anticato / Ottone pre-anticato
Fissaggio: Su superficie / Picchetto / Cintura per albero
Cavo di alimentazione: 100cm NS20N PCP 2x0,5mm²
Alimentazione: Tensione costante 24Vdc
Potenza assorbita: 2,6 Watt / 3,6 Watt
CRI: >90
Selezione bin: Binning free 2 step MacAdam's
Flusso sorgente: 188 lm / 263 lm (3000K)
Flusso apparecchio: 174 lm / 215 lm (3000K)
Temperatura di funzionamento: -20°C +50°C
Grado di protezione: IP66
Classe d'isolamento: Classe III
Protezione impatto: IK07
Peso: 270g alluminio / 990g ottone
Ottiche: 10° / 23° / 43° / 10°x 40° / 40°x10°
Temperatura colore LED: 2200K / 2700K / 3000K / 4000K
Vita media LED: 50000h L95 B10 (Ta 25°C)
Rischio fotobiologico: RGO / RG1

PHOTOMETRICS / CURVE FOTOMETRICHE:

10° - 3,6 Watt

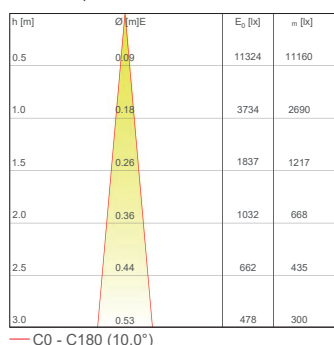

23° - 3,6 Watt

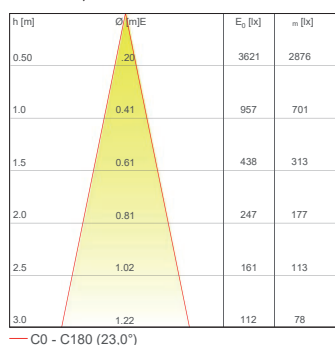

43° - 3,6 Watt

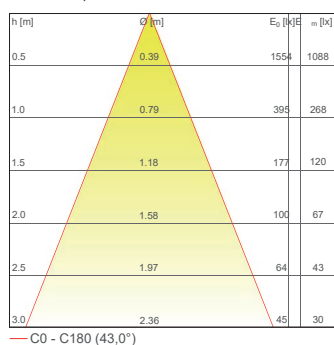

40°x10° - 3,6 Watt

