



IP68

TRAIL 54 Q

Trail 54 Q is a compact square, recessed, louvered steplight machined out of solid brass and pre aged. This makes Trail 54 Q extremely durable even in moist salt-air environments and suitable for applications where safety is a priority. The positioning and angles of the louvres allow for a complete glare free asymmetric light beam. Trail 54 Q offers a choice of four colour temperatures as standard (2200K, 2700K, 3000K and 4000K) and delivers 90CRI for excellent colour rendering, and with binning-free LEDs carefully selected from two-step Macadam's ellipses, colour consistency is assured throughout the unonovesette portfolio.

Trail 54 Q è un apparecchio a LED quadrato compatto da incasso, con griglia frontale inclinata e finitura in ottone anticato.

Trail 54 Q è estremamente durevole anche in ambienti con aria salmastra umida e adatto per applicazioni dove la sicurezza è una priorità. Il posizionamento e gli angoli delle persiane consentono un fascio luminoso asimmetrico completamente privo di abbagliamento. Trail 54 Q offre una scelta di quattro temperature colore (2200K, 2700K, 3000K e 4000K) tutte con CRI maggiore di 90 per una eccellente resa cromatica. Binning-free e due-step MacAdam's ellipses LED, assicurano consistenza del colore in tutte le versioni previste da unonovesette

TECHNICAL DATA / DATI TECNICI:

 IP68

 2W

 140 lm (3000K)

 >90





 2200K / 2700K / 3000K / 4000K

 Asymmetric

 Smart Shield

FINISHES / FINITURE:

 Black anodized
Anodizzato nero

 Aged solid brass
Ottone anticato

 Pre-aged solid brass
Ottone pre-anticato

OPTICS / OTTICHE:

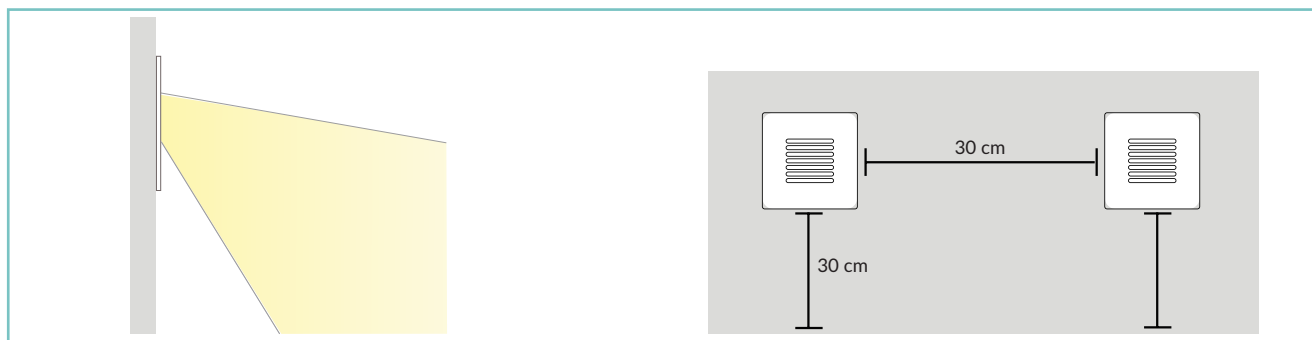

unonovasette

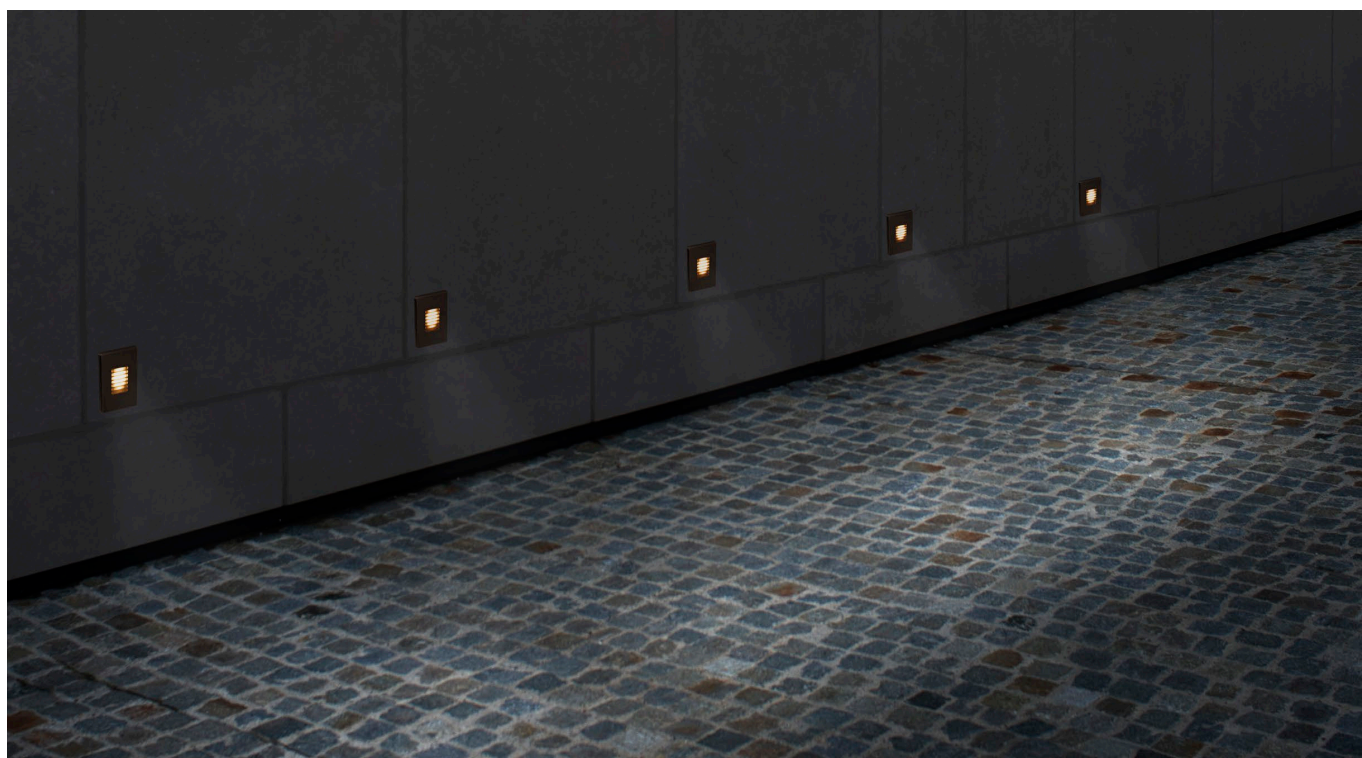

unonovesette

PRODUCT CODE / CODICE PRODOTTO:

TR5Q = TRAIL 54 Q		Select one component from each column to specify a complete configuration: Selezionare un componente per ogni colonna per la configurazione completa:			
	LED colour / Colore LED	Optics / Ottiche	Finish / Finiture	Power / Potenza	
	22 = 2200K 27 = 2700K 30 = 3000K 40 = 4000K	A = Asymmetric	05 = Black anodized / Anodizzato nero 10 = Aged solid brass / Ottone anticato 21 = Pre-aged solid brass / Ottone pre-anticato	02 = 2W	

Standard configuration example/
Esempio di configurazione standard:

TR5Q.30.A.05.02 Trail 54 Q 3000K asymmetric optics black anodized / Anodizzato nero 2W

POWER SUPPLIES 24Vdc CONSTANT VOLTAGE / ALIMENTATORE TENSIONE COSTANTE 24Vdc:

On / Off

Code / Codice	Input	I Out	V Out	Watt	IP	#Trail 54 Q
PSU.CX.004	110+240V / 50/60 Hz	0,9 A	24Vdc	20	IP20	Max 8
PSU.CV.005	90+305V / 47/63 Hz	1 A	24Vdc	25	IP67	Max 9
PSU.CV.006	90+305V / 47/63 Hz	2,5 A	24Vdc	60	IP67	Max 25
PSU.CV.007	90+305V / 47/63 Hz	3,75 A	24Vdc	90	IP67	Max 36
PSU.CV.021	90+305V / 47/63 Hz	10 A	24Vdc	240	IP67	Max 80

Control gear / Elettronica di controllo

Code / Codice	Input	I Out	V Out	Watt	IP	#Trail 54 Q
CGE.004 - 0/1-10V	24Vdc	6,5 A	24Vdc	156	IP20	Max 70
CGE.017 - DALI	24Vdc	6,5 A	24Vdc	156	IP20	Max 70
CGE.017.IP - DALI	24Vdc	6,5 A	24Vdc	156	IP67	Max 70
CGE.020 - DMX	24Vdc	6,5 A	24Vdc	156	IP20	Max 70

ACCESSORIES / ACCESSORI

		
Housing box Cassaforma HB.009 (70g)	Fixing springs Molle di fissaggio ACC.050	Cable Cavo CV00037 5m CV00040 10m CV00041 15m CV00042 20m CV00043 25m

TECHNICAL DRAWING / DISEGNO TECNICO:

RECESSED HOLE / FORO INCASSO:

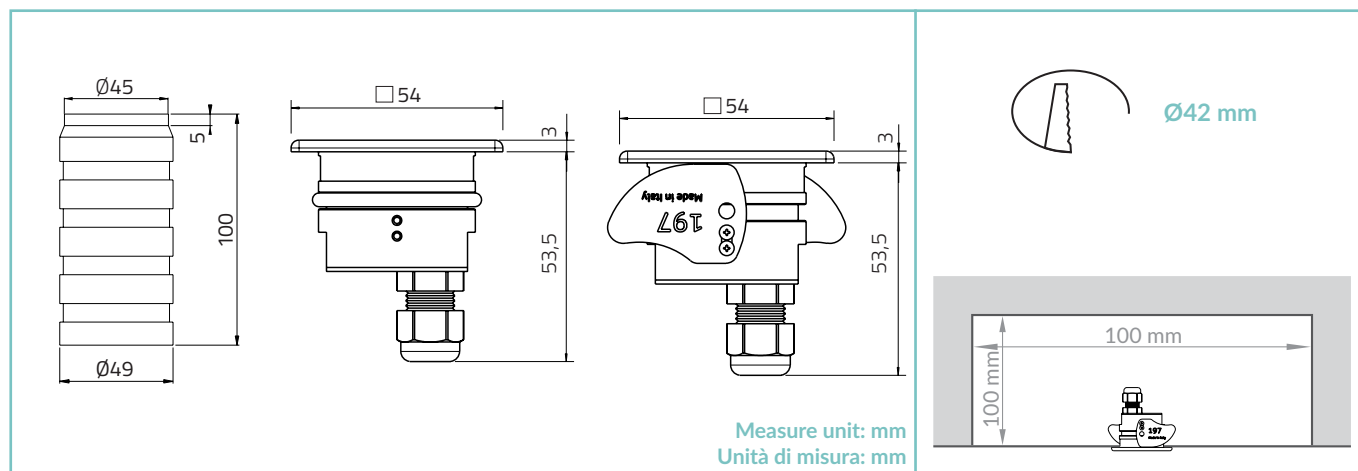

TECHNICAL SHEET / SCHEDA PRODOTTO:

Body: Anodized aluminium 6026 / Solid brass - Anodized aluminium 6026

Glass: Glass 2mm

Finishes: Black anodized / Aged solid brass / Pre-aged solid brass

Installation: Housing box / Fixing springs

Power supply cables: 35cm NS20N PCP 2x0,5mm²

Power supply: Constant voltage 24Vdc

Power consumption: 2 Watt

CRI: >90

Bin selection: Binning free 2 step MacAdam's

Lumen output (source): 140 lm (3000K)

Lumen output (delivered): 20 lm (3000K)

Operating temperature: -20°C +50°C

IP rating: IP68 (not for permanent immersion)

Insulation class: Class III

Weight: 208g

Optics: Asymmetric

LED colour temperature: 2200K / 2700K / 3000K / 4000K

Lifetime LED: 50000h L95 B10 (Ta 25°C)

Photo biological risk: RGO / RG1

Corpo: Alluminio 6026 anodizzato / Ottone - Alluminio 6026 anodizzato

Vetro: Vetro 2mm

Finiture: Anodizzato nero / Ottone anticato / Ottone pre-anticato

Fissaggio: Cassaforma / Molle di fissaggio

Cavo di alimentazione: 35cm NS20N PCP 2x0,5mm²

Alimentazione: Tensione costante 24Vdc

Potenza assorbita: 2 Watt

CRI: >90

Selezione bin: Binning free 2 step MacAdam's

Flusso sorgente: 140 lm (3000K)

Flusso apparecchio: 20 lm (3000K)

Temperatura di funzionamento: -20°C +50°C

Grado di protezione: IP68 (non per immersione permanente)

Classe d'isolamento: Classe III

Peso: 208g

Ottiche: Assimmetrico

Temperatura colore LED: 2200K / 2700K / 3000K / 4000K

Vita media LED: 50000h L95 B10 (Ta 25°C)

Rischio fotobiologico: RGO / RG1

PHOTOMETRICS / CURVE FOTOMETRICHE:

2 Watt

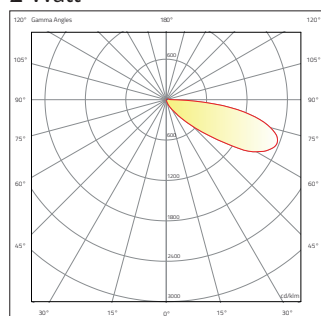

— C0 - C180