









IP40

## NILO D



Nilo D is a miniature directional recessed LED luminaire providing high performance discrete accent lighting from a compact source. Nilo D offers a choice of four colour temperatures as standard (2200K, 2700K, 3000K and 4000K) and delivers 90 CRI for excellent colour rendering, with binning-free LEDs carefully selected from two-step MacAdam's ellipses. Colour consistency is assured throughout the unonovesette portfolio. Nilo D is perfectly suitable for illumination of niches, under cabinets, under shelves or accent downlighting. The optional rotatable snout offers the possibility to hide the light source from any viewing angle.

*Nilo D è un faretto LED orientabile da incasso miniaturizzato ad alte prestazioni per una luce d'accento discreta da una sorgente compatta. Nilo D offre una scelta fra quattro temperature di colore standard (2200K, 2700K, 3000K e 4000K) tutte con CRI maggiore di 90 per una eccellente resa cromatica. Binning-free e due-step MacAdam's ellipses LED, assicurano consistenza del colore in tutte le versioni previste da unonovesette. Nilo D è ideale per illuminare nicchie, interno armadi, sotto mensole o come luce d'accento a soffitto. Il paraluce orientabile opzionale offre la possibilità di nascondere il punto luce da qualunque punto di osservazione.*

### TECHNICAL DATA / DATI TECNICI:

 IP40	 2200K / 2700K / 3000K / 4000K
 2W	 10° / 23° / 43° / 70° / 10°x40°
 140 lm (3000K)	
 >90	
	

### FINISHES / FINITURE:

	White RAL 9003 Bianco RAL 9003
	Black RAL 9005 Nero RAL 9005

### OPTICS / OTTICHE:

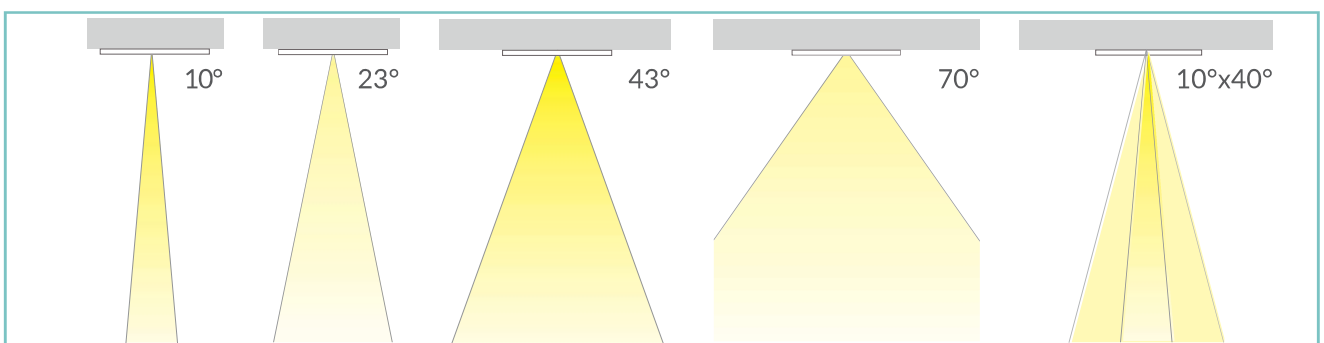



# unonovesette

## PRODUCT CODE / CODICE PRODOTTO:

NID = NILO D		Select one component from each column to specify a complete configuration: Selezionare un componente per ogni colonna per la configurazione completa:		
		LED colour / Colore LED	Optics / Ottiche	Finish / Finiture
		22 = 2200K 27 = 2700K 30 = 3000K 40 = 4000K	N = 10° M = 23° W = 43° R = 70° E = 10°x40°	01 = White RAL 9003 / Bianco RAL 9003 02 = Black RAL 9005 / Nero RAL 9005

Standard configuration example/  
Esempio di configurazione standard:

**NID.30.N.01 Nilo D 3000K 10° optics white / bianco**

## POWER SUPPLIES 500mA CONSTANT CURRENT / ALIMENTATORE CORRENTE COSTANTE 500mA:

On / Off

Code / Codice	Input	I Out	V Out	Watt	IP	#Nilo D
PSU.CX.003	110+240V / 50/60 Hz	500mA	47 V	24	IP20	Max 13
PSU.CX.004	110+240V / 50/60 Hz	500mA	43 V	20	IP20	Max 10

Dimmable / Dimmerabile

Code / Codice	Input	I Out	V Out	Watt	IP	#Nilo D
PSU.CX.001 1-10V/PUSH	100+240V / 50/60 Hz	500mA	47 V	24	IP20	Max 13
PSU.CX.002 DALI	100+240V / 50/60 Hz	500mA	47 V	24	IP20	Max 13

## ACCESSORIES / ACCESSORI

		
	Snoot Paraluce	
	ACC.018.01 white/bianco	
	ACC.018.02 black/nero	

TECHNICAL DRAWING / DISEGNO TECNICO:

RECESSED HOLE / FORO INCASSO:

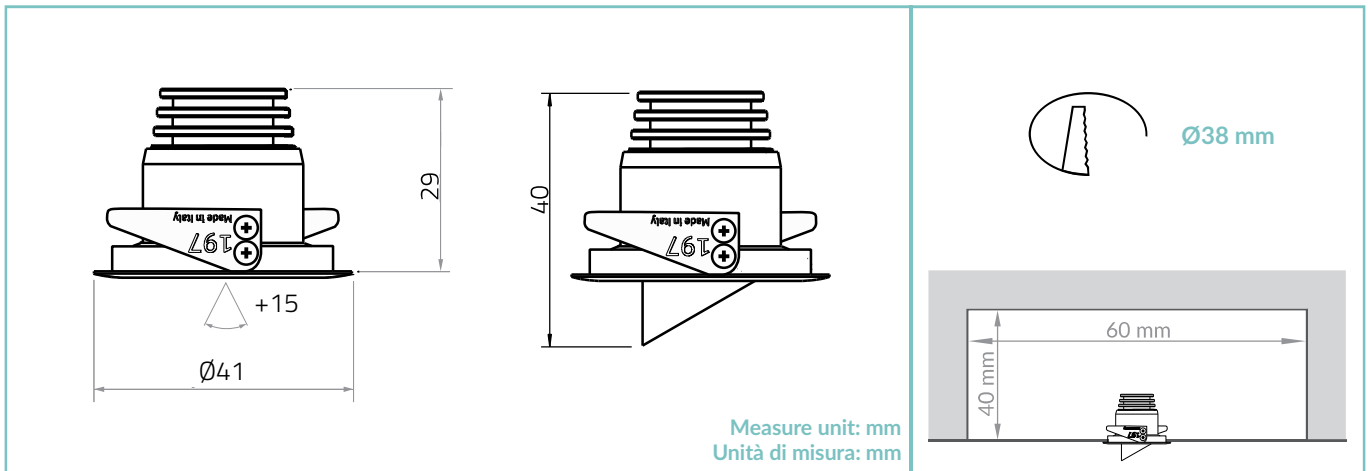

TECHNICAL SHEET / SCHEDA PRODOTTO:

**Body:** Aluminium 6026  
**Finishes:** White RAL 9003 / Black RAL 9005  
**Installation:** Fixing springs  
**Power supply cables:** 20 cm cable 2x0.5 mm<sup>2</sup>  
**Power supply:** Constant current 500mA Max  
**Power consumption:** 2 Watt  
**CRI:** >90  
**Bin selection:** Binning free 2 step MacAdam's  
**Lumenoutput (source):** 140 lm (3000K)  
**Operating temperature:** -20°C +50°C  
**IP rating:** IP40 / IP44 installed  
**Insulation class:** Class III  
**Weight:** 40 g  
**Optics:** 10° / 23° / 43° / 70° / 10°x40°  
**LED colour temperature:** 2200K / 2700K / 3000K / 4000K  
**Lifetime LED:** 100000 hrs  
**Photo biological risk:** RG0 / RG1

**Corpo:** Alluminio 6026  
**Finiture:** Bianco RAL 9003 / Nero RAL 9005  
**Fissaggio:** Molle di fissaggio  
**Cavo di alimentazione:** 20 cm cavo 2x0,5 mm<sup>2</sup>  
**Alimentazione:** Corrente costante 500mA Max  
**Potenza assorbita:** 2 Watt  
**CRI:** >90  
**Selezione bin:** Binning free 2 step MacAdam's  
**Flusso luminosoc (sorgente):** 140 lm (3000K)  
**Temperatura di funzionamento:** -20°C +50°C  
**Grado di protezione:** IP40 / IP44 installato  
**Classe d'isolamento:** Classe III  
**Peso:** 40 g  
**Ottiche:** 10° / 23° / 43° / 70° / 10°x40°  
**Temperatura colore LED:** 2200K / 2700K / 3000K / 4000K  
**Vita media LED:** 100000 hrs  
**Rischio fotobiologico:** RG0 / RG1

PHOTOMETRICS / CURVE FOTOMETRICHE:

10° - 2 Watt

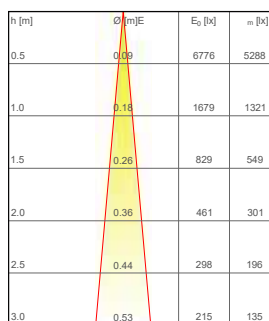

— C0 - C180 (10,0°)

23° - 2 Watt

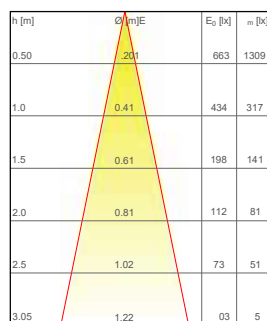

— C0 - C180 (23,0°)

43° - 2 Watt

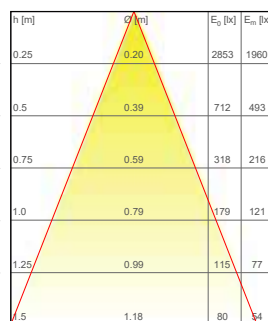

— C0 - C180 (43,0°)

70° - 2 Watt

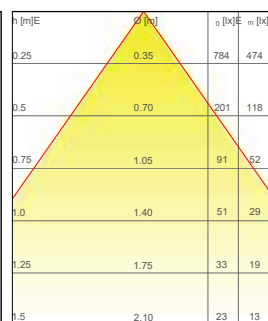

— C0 - C180 (70,0°)

10°x40° - 2 Watt

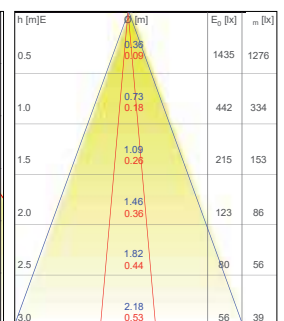

— C0 - C180 (10,0°) — C90 - C270 (40,0°)