











IP40

NILO D



Nilo D is a miniature directional recessed LED luminaire providing high performance discrete accent lighting from a compact source. Nilo D offers a choice of four colour temperatures as standard (2200K, 2700K, 3000K and 4000K) and delivers 90 CRI for excellent colour rendering, with binning-free LEDs carefully selected from two-step MacAdam's ellipses. Colour consistency is assured throughout the unonovesette portfolio. Nilo D is perfectly suitable for illumination of niches, under cabinets, under shelves or accent downlighting. The optional rotatable snoot offers the possibility to hide the light source from any viewing angle.

Nilo D est un spot à LED miniaturisé encastrable haute performance pour un éclairage d'accentuation discret à partir d'une source compacte, offrant une rotation verticale de +/-15°. Nilo D offre un choix de températures de couleur standard (2200K, 2700K, 3000K et 4000K), et délivre 90 IRC pour un excellent rendu des couleurs Binning-free et 2 step MacAdam garantissent la cohérence des couleurs dans toutes les versions fournies par unonovesette. Nilo D est idéal pour éclairer des niches, des armoires, des étagères ou un éclairage d'accentuation au plafond. La casquette réglable en option offre la possibilité de masquer le point lumineux des tous points d'observation.

TECHNICAL DATA / FICHE TECHNIQUE:

 IP40	 2200K / 2700K / 3000K / 4000K
 2W	 10° / 23° / 43° / 70° / 10°x40°
 140 lm (3000K)	 CE
 A++	
 CRI >90	

FINISHES / FINITIONS:

	White RAL 9003 Blanc RAL 9003
	Black RAL 9005 Noir RAL 9005

OPTICS / FAISCEAU:

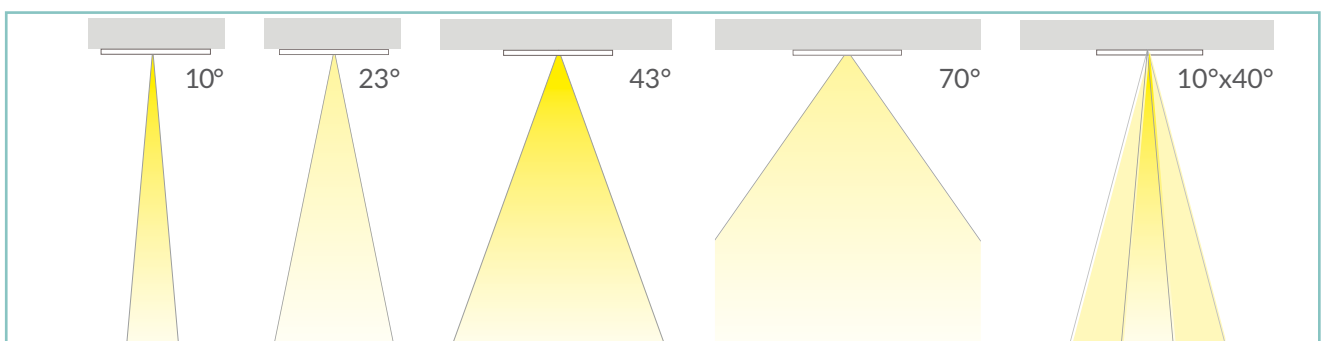



unonovesette

PRODUCT CODE/CODE PRODUIT:

NID = NILO D		Select one component from each column to specify a complete configuration: Sélectionner un composant pour chaque colonne pour une configuration complète:		
		LED colour / Couleur LED	Optics / Faisceau	Finish / Finitions
		22 = 2200K	N = 10°	01 = White RAL 9003 / Blanc RAL 9003
		27 = 2700K	M = 23°	02 = Black RAL 9005 / Noir RAL 9005
		30 = 3000K	W = 43°	
		40 = 4000K	R = 70°	
			E = 10°x40°	

Standard configuration example/
Exemple de configuration standard:

NID.30.N.01 Nilo D 3000K 10° optics white / blanc

POWER SUPPLIES 500mA CONSTANT CURRENT / ALIMENTATEUR COURANT CONSTANT 500 mA:

On / Off

Code / Code	Input	I Out	V Out	Watt	IP	#Nilo D
PSU.CX.003	100+240V / 50/60 Hz	500mA	47 V	24	IP20	Max 12
PSU.CX.004	90+305V / 47/63 Hz	500mA	43 V	20	IP20	Max 9

Dimmable / Gradable

Code / Code	Input	I Out	V Out	Watt	IP	#Nilo D
PSU.CX.001 1-10V/PUSH	100+240V / 50/60 Hz	500mA	47 V	24	IP20	Max 12
PSU.CC.011 DALI	100+240V / 50/60 Hz	500mA	47 V	24	IP20	Max 12

ACCESSORIES / ACCESSOIRES



TECHNICAL DRAWING / DESSIN TECHNIQUE:

RECESSED HOLE / TROU D'ENCASTREMENT:

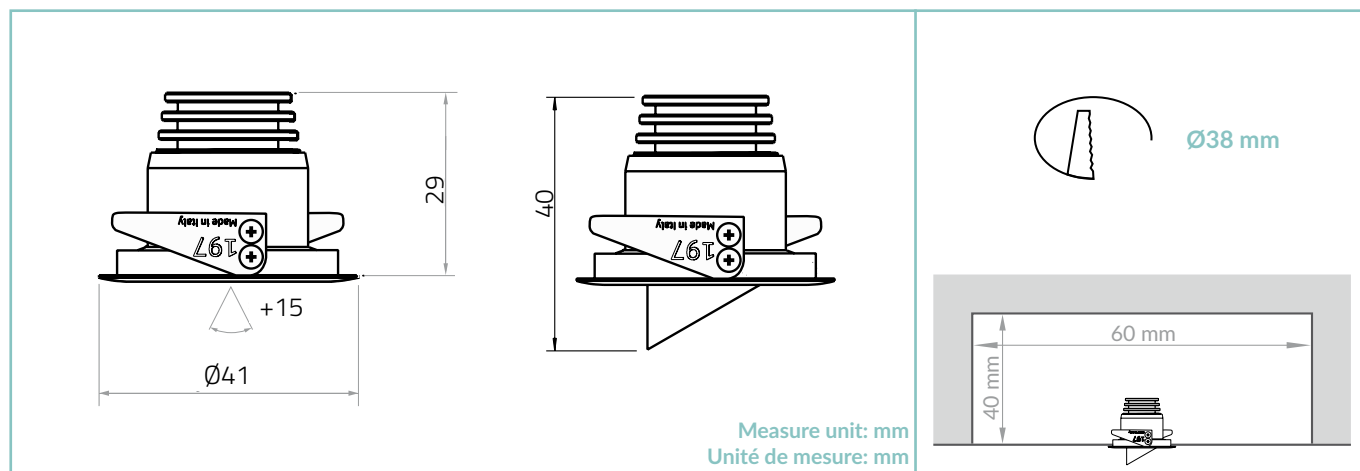

TECHNICAL SHEET / FICHE PRODUIT:

Body: Aluminium 6026
Finishes: White RAL 9003 / Black RAL 9005
Installation: Fixing springs
Power supply cables: 20 cm 2x0.5 mm²
Power supply: Constant current 500mA Max
Power consumption: 2 Watt
CRI: >90
Bin selection: Binning free 2 step MacAdam's
Lumenoutput (source): 140 lm (3000K)
Operating temperature: -20°C +50°C
IP rating: IP40 / IP44 installed
Insulation class: Class III
Weight: 40 g
Optics: 10° / 23° / 43° / 70° / 10°x40°
Energy rating: A++
LED colour temperature: 2200K / 2700K / 3000K / 4000K
Lifetime LED: 100000 hrs
Photo biological risk: RGO / RG1

Corps: Alluminium 6026
Finitions: Blanc RAL 9003 / Noir RAL 9005
Installation: Ressorts de montage
Câbles d'alimentation: 20 cm 2x0,5 mm²
Alimentation: Courant constant 500mA Max
Puissance absorbée: 2 Watt
IRC Indice de Rendu des Couleurs: >90
Sélection du bin: Binning free 2 step MacAdam's
Flux de la source: 140 lm (3000K)
Température de fonctionnement: -20°C +50°C
Indice de protection: IP40 / IP44 Installé
Classe d'isolation: Classe III
Poids: 40 g
Optiques: 10° / 23° / 43° / 70° / 10°x40°
Classe d'efficacité énergétique: A++
Couleur LED: 2200K / 2700K / 3000K / 4000K
Durée moyenne LED: 100000 hrs
Sécurité photobiologique: RGO / RG1

PHOTOMETRICS / COURVES PHOTOMETRIQUE:

