









IP40

NILO

Nilo is a miniature recessed LED luminaire providing high performance discrete accent lighting from a compact source. Nilo offers a choice of four colour temperatures as standard (2200K, 2700K, 3000K and 4000K) and delivers 90 CRI for excellent colour rendering, with binning-free LEDs carefully selected from two-step MacAdam's ellipses. Colour consistency is assured throughout the unonovesette portfolio. Nilo is perfectly suitable for illumination of niches, under cabinets, under shelves or accent downlighting. The optional rotatable snoot offers the possibility to hide the light source from any viewing angle.

Nilo è un faretto LED da incasso miniaturizzato ad alte prestazioni per una luce d'accento discreta da una sorgente compatta. Nilo offre una scelta fra quattro temperature di colore standard (2200K, 2700K, 3000K e 4000K) tutte con CRI maggiore di 90 per una eccellente resa cromatica. Binning-free e due-step MacAdam's ellipses LED, assicurano consistenza del colore in tutte le versioni previste da unonovesette. Nilo è ideale per illuminare nicchie, interno armadi, sotto mensole o come luce d'accento a soffitto. Il paraluce orientabile opzionale offre la possibilità di nascondere il punto luce da qualunque punto di osservazione.

TECHNICAL DATA / DATI TECNICI:

 IP40	 2200K / 2700K / 3000K / 4000K
 2W	 10° / 23° / 43° / 70° / 10°x40°
 140 lm (3000K)	
 >90	
	

FINISHES / FINITURE:

	White RAL 9003 Bianco RAL 9003
	Black RAL 9005 Nero RAL 9005
	Flamed bronze Bronzo brunito

OPTICS / OTTICHE:

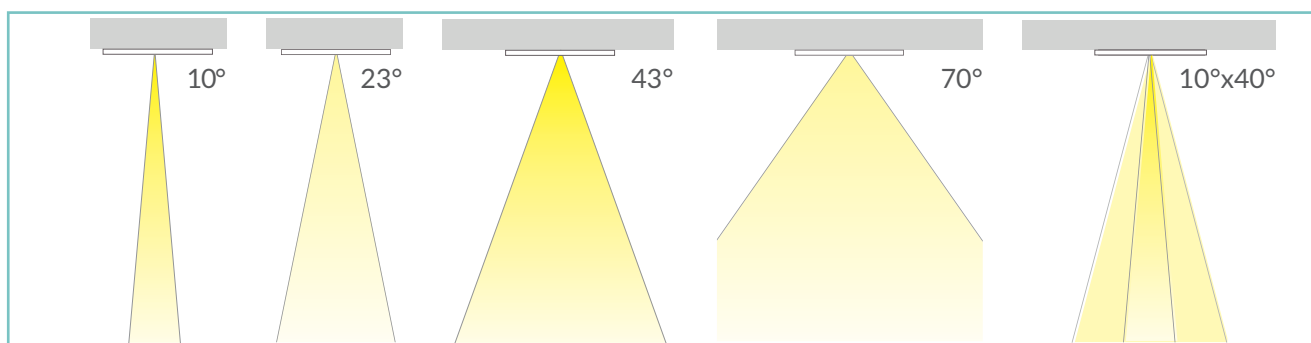

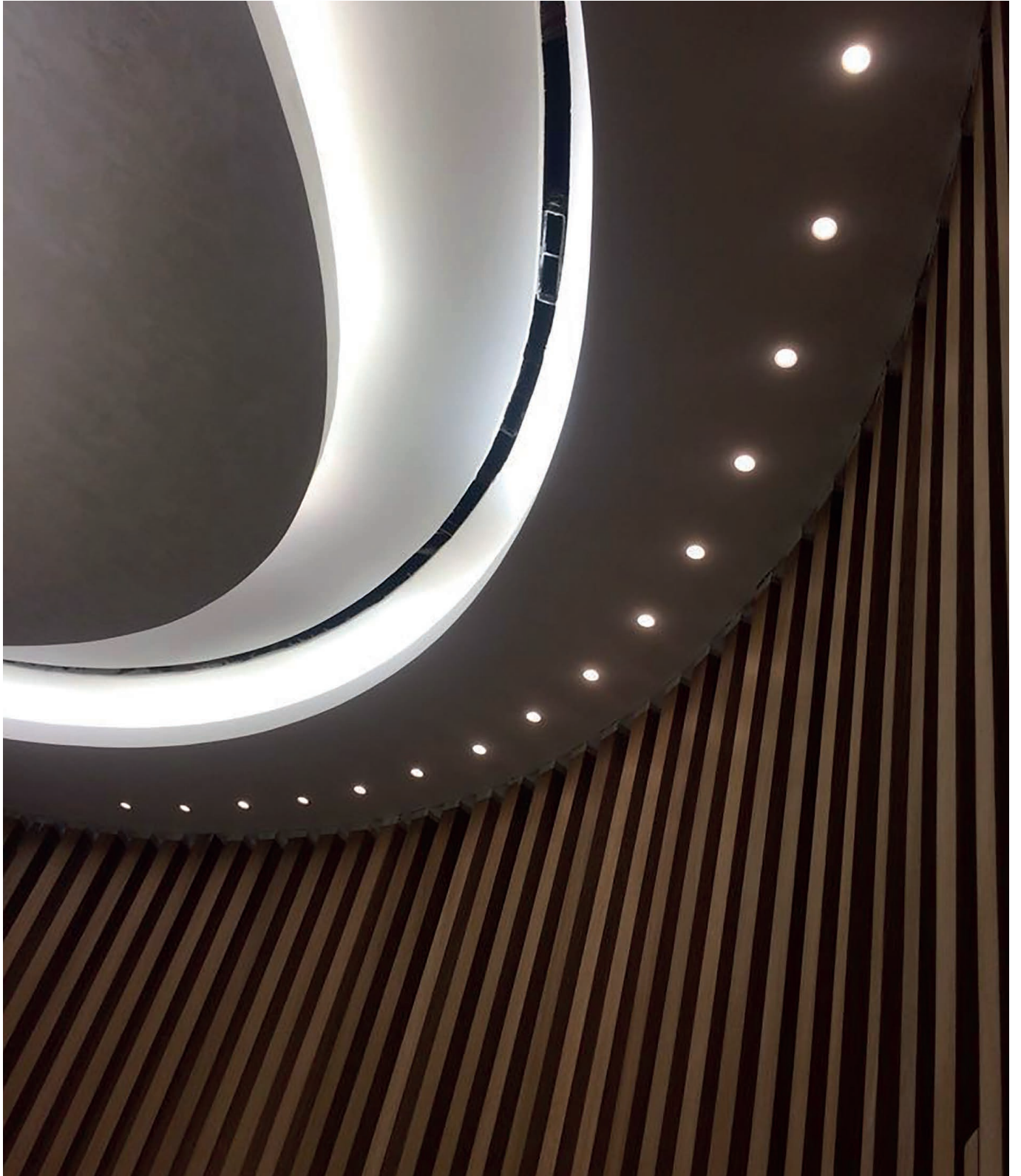

PRODUCT CODE / CODICE PRODOTTO:

NIL = NILO		Select one component from each column to specify a complete configuration: Selezionare un componente per ogni colonna per la configurazione completa:			
		LED colour / Colore LED	Optics / Ottiche	Finish / Finiture	Power / Potenza
		22 = 2200K 27 = 2700K 30 = 3000K 40 = 4000K	N = 10° M = 23° W = 43° R = 70° E = 10°x40°	01 = White RAL 9003 / Bianco RAL 9003 02 = Black RAL 9005 / Nero RAL 9005 16 = Flamed bronze / Bronzo brunito	CC = 500mA

Standard configuration example/
Esempio di configurazione standard:

NIL.30.N.01.CC Nilo 3000K 10° optics white / Bianco 500mA

POWER SUPPLIES 500mA CONSTANT CURRENT / ALIMENTATORE CORRENTE COSTANTE 500mA:

On / Off

Code / Codice	Input	I Out	V Out	Watt	IP	#Nilo
PSU.CX.003	110+240V / 50/60 Hz	500mA	47 V	24	IP20	Max 13
PSU.CX.004	110+240V / 50/60 Hz	500mA	43 V	20	IP20	Max 11

Dimmable / Dimmerabile

Code / Codice	Input	I Out	V Out	Watt	IP	#Nilo
PSU.CX.001 1-10V/PUSH	100+240V / 50/60 Hz	500mA	47 V	24	IP20	Max 13
PSU.CC.011 DALI	100+240V / 50/60 Hz	500mA	38 V	20	IP20	Max 10

ACCESSORIES / ACCESSORI

		
	Snoot Paraluze	
	ACC.018.01 white/bianco	
	ACC.018.02 black/nero	

TECHNICAL DRAWING / DISEGNO TECNICO:

RECESSED HOLE / FORO INCASSO:

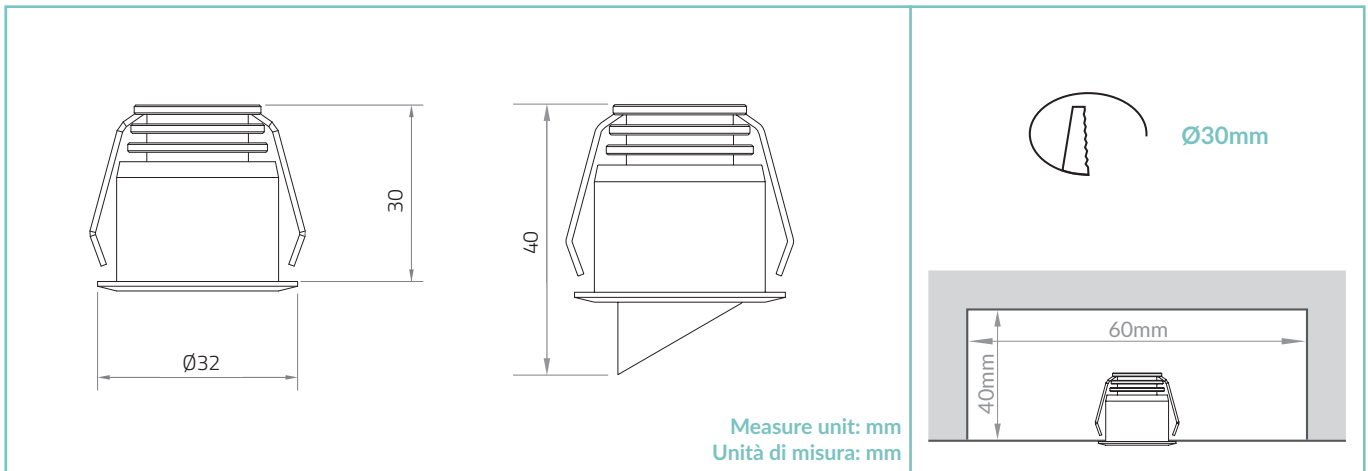

TECHNICAL SHEET / SCHEDA PRODOTTO:

Body: Aluminium 6026
Finishes: White RAL 9003 / Black RAL 9005 / Flamed bronze
Installation: Fixing springs
Power supply cables: 20cm cable 2x0.5mm²
Power supply: Constant current 500mA Max
Power consumption: 2 Watt
CRI: >90
Bin selection: Binning free 2 step MacAdam's
Lumenoutput (source): 140 lm (3000K)
Lumenoutput (delivered): 119 lm (3000K)
Operating temperature: -20°C +50°C
IP rating: IP40 / IP44 installed
Insulation class: Class III
Weight: 30g
Optics: 10° / 23° / 43° / 70° / 10°x40°
LED colour temperature: 2200K / 2700K / 3000K / 4000K
Lifetime LED: 50000h L95 B10 (Ta 25°C)
Photo biological risk: RGO / RG1

Corpo: Alluminio 6026
Finiture: Bianco RAL 9003 / Nero RAL 9005 / Bronzo brunito
Fissaggio: Molle di fissaggio
Cavo di alimentazione: 20cm cavo 2x0,5mm²
Alimentazione: Corrente costante 500mA Max
Potenza assorbita: 2 Watt
CRI: >90
Selezione bin: Binning free 2 step MacAdam's
Flusso sorgente: 140 lm (3000K)
Flusso apparecchio: 119 lm (3000K)
Temperatura di funzionamento: -20°C +50°C
Grado di protezione: IP40 / IP44 installato
Classe d'isolamento: Classe III
Peso: 30g
Ottiche: 10° / 23° / 43° / 70° / 10°x40°
Temperatura colore LED: 2200K / 2700K / 3000K / 4000K
Vita media LED: 50000h L95 B10 (Ta 25°C)
Rischio fotobiologico: RGO / RG1

PHOTOMETRICS / CURVE FOTOMETRICHE:

10° - 2 Watt

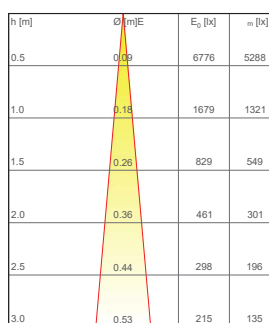

— C0 - C180 (10,0°)

23° - 2 Watt

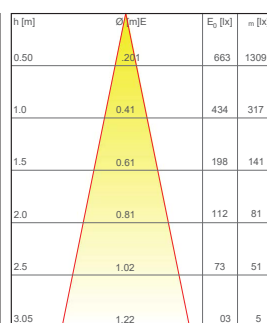

— C0 - C180 (23,0°)

43° - 2 Watt

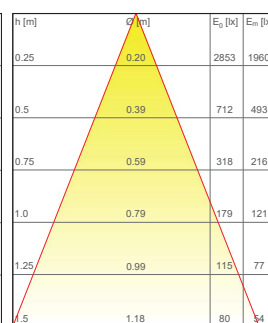

— C0 - C180 (43,0°)

70° - 2 Watt

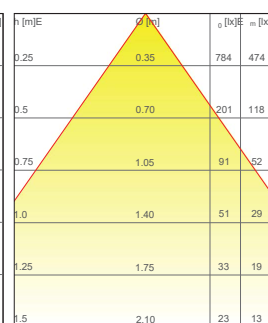

— C0 - C180 (70,0°)

10°x40° - 2 Watt

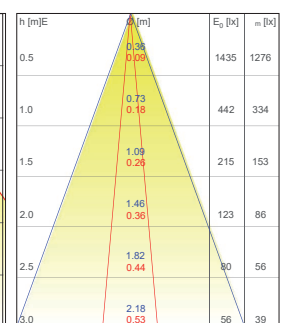

— C0 - C180 (10,0°) — C90 - C270 (40,0°)