



IP20



MAXIMA

Maxima is a professional fixed downlight LED luminaire, with a deep recessed COB LED light source and features high efficiency reflector technology for excellent glare control and uniformity. Maxima offers a choice of three colour temperatures as standard (2700K, 3000K and 4000k) and delivers 90 CRI for excellent colour rendering. With binning-free LEDs carefully selected from two-step MacAdam's ellipses, colour consistency is assured throughout the unonovesette portfolio. Available with a choice of three beam angles (20°, 32° and 40°).

Maxima est un projecteur encastré à LED professionnel, avec une position en retrait de la source de lumière à LED COB. Grâce à la technologie des réflecteurs, il offre une excellente uniformité et un contrôle de l'éblouissement. Des alimentations compatibles pour Maxima sont disponibles pour le contrôle DALI ou 1-10V. Les options installées en usine incluent grille nid d'abeille pour un meilleur contrôle de l'éblouissement et un diffuseur micro-prismatique. Il a un IRC de 90 pour un excellent rendu des couleurs. Binning-free et 2 step MacAdam garantissent la cohérence des couleurs dans toutes les versions fournies par unonovesette. Il est disponible avec trois optiques différentes (20°, 32° et 40°).

TECHNICAL DATA / FICHE TECHNIQUE:

 IP20

 Up to 12,9W @ 500mA
Up to 11,8W (Dim to Warm)

 1154 lm (3000K)
1045 lm - 28 lm (DTW)

 >90



 2700K / 3000K / 4000K
Dim to warm (3000K - 1800K)

 20° / 32° / 40° / (20° / 40° DTW)

FINISHES / FINITIONS:

 White RAL 9003
Blanc RAL 9003

 Black RAL 9005
Noir RAL 9005

OPTICS / FAISCEAU:

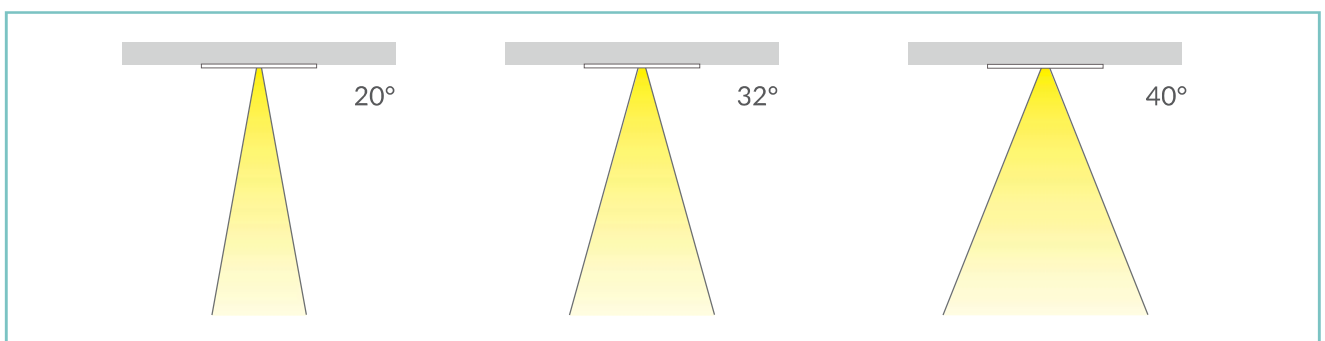

unonovesette



unonovesette

PRODUCT CODE/CODE PRODUIT:

MAX = MAXIMA		Select one component from each column to specify a complete configuration: <i>Sélectionner un composant pour chaque colonne pour une configuration complète:</i>		
		LED colour / Couleur LED	Optics / Faisceau	Finish / Finitions
		27 = 2700K 30 = 3000K 40 = 4000K DW = Dim to warm	N = 20° (20° DTW) M = 32° W = 40° (40° DTW)	01 = White RAL 9003 / Blanc RAL 9003 02 = Black RAL 9005 / Noir RAL 9005

Standard configuration example/
Exemple de configuration standard:

MAX.30.N.01 Maxima 3000K 20° optics white / blanc

POWER SUPPLIES 500mA CONSTANT CURRENT / ALIMENTATEUR COURANT CONSTANT 500 mA:

On / Off

Code / Code	Input	I Out	V Out	Watt	IP	#Maxima
PSU.CX.003	110+240V / 50/60 Hz	500mA	47 V	24	IP20	Max 1
PSU.CX.004	110+240V / 50/60 Hz	500mA	43 V	20	IP20	Max 1

Dimmable / Gradable

Code / Code	Input	I Out	V Out	Watt	IP	#Maxima
PSU.CX.001 1-10V/PUSH	100+240V / 50/60 Hz	500mA	47 V	15	IP20	Max 1
PSU.CX.011 DALI	220+240V / 47/53 Hz	500mA	40 V	20	IP20	Max 1
PSU.CC.022 DTW / DALI	220+240V / 47/53 Hz	350mA	40 V	20	IP20	Max 1

ACCESSORIES / ACCESSOIRES

	
Honeycomb louver <i>Grille nid d'abeille</i> ACC.001	Micro prismatic diffuser <i>Diffuseur micro prismatique</i> ACC.002



MAXIMA

TECHNICAL DRAWING / DESSIN TECHNIQUE:

RECESSED HOLE / TROU D'ENCASTREMENT:

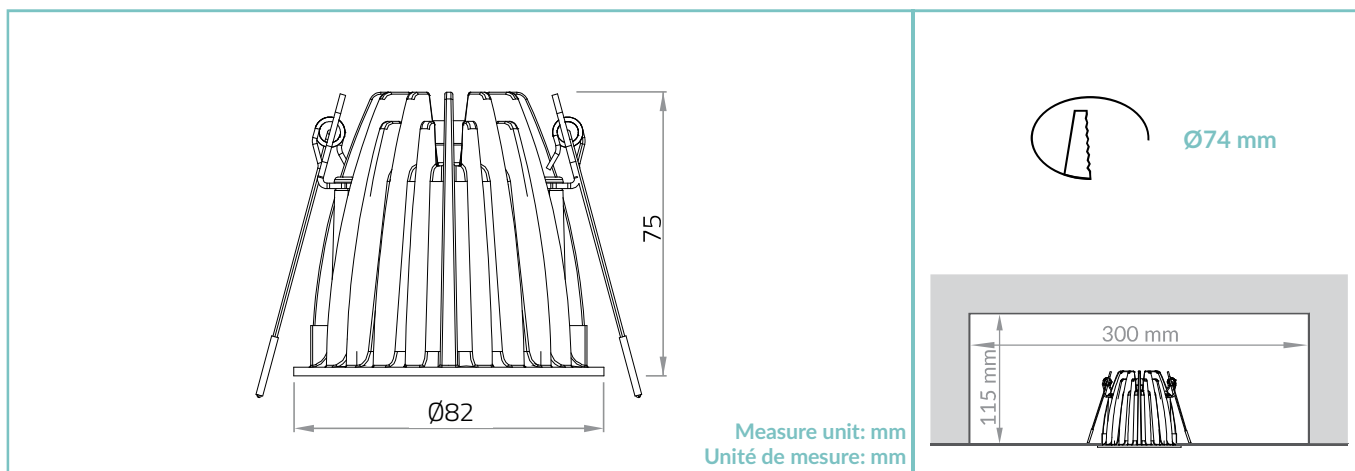

TECHNICAL SHEET / FICHE PRODUIT:

Body: Die-cast aluminium
Finishes: White RAL 9003 / Black RAL 9005
Installation: Fixing springs
Power supply cables: 30 cm PVC + PVC 2x0,5 mm²
Power supply: Constant current 500mA Max / (350mA-14mA Dim to warm)
Power consumption: 12,9 Watt Max
CRI: >90
Bin selection: Binning free 2 step MacAdam's
Lumenoutput (source): 1154 lm (3000K) / 1045 lm - 28 lm (DTW)
Operating temperature: -20°C +50°C
IP rating: IP20
Insulation class: Class III
Weight: 235 g
Optics: 20° / 32° / 40° / (20° / 40° DTW)
LED colour temperature: 2700K / 3000K / 4000K / (3000K - 1800K DTW)
Lifetime LED: 100000 hrs
Photo biological risk: RG0 / RG1

Corps: Aluminium moulé sous pression
Finitions: Blanc RAL 9003 / Noir RAL 9005
Installation: Ressorts de montage
Câbles d'alimentation: 30 cm PVC + PVC 2x0,5 mm²
Alimentation: Courant constant 500mA Max / (350mA-14mA Dim to warm)
Puissance absorbée: 12,9 Watt Max
IRC Indice de Rendu des Couleurs: >90
Sélection du bin: Binning free 2 step MacAdam's
Flux de la source: 1154 lm (3000K) / 1045 lm - 28 lm (DTW)
Température de fonctionnement: -20°C +50°C
Indice de protection: IP20
Classe d'isolation: Classe III
Poids: 235 g
Optiques: 20° / 32° / 40° / (20° / 40° DTW)
Couleur LED: 2700K / 3000K / 4000K / (3000K - 1800K DTW)
Durée moyenne LED: 100000 hrs
Sécurité photobiologique: RG0 / RG1

PHOTOMETRICS / COURVES PHOTOMETRIQUE:

20° - 12,9 Watt

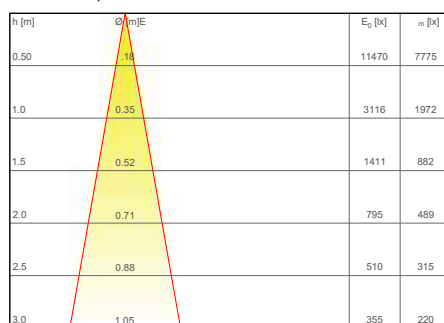

32° - 12,9 Watt

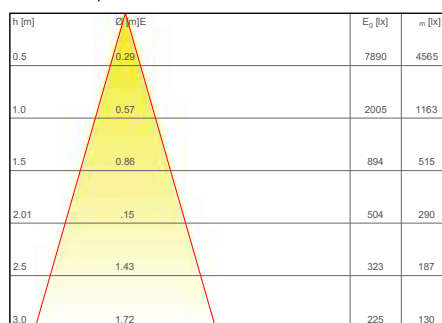

40° - 12,9 Watt

