











IP68

## EXPLORER 65-2



Explorer 65-2 is a radial floor washer designed to light flat areas, decks and paths. Explorer 65-2 offers a choice of three colour temperatures as standard (2200K, 2700K, 3000K, 4000K) and delivers 90CRI for excellent colour rendering, and with binning-free LEDs carefully selected from two-step Macadam's ellipses, colour consistency is assured throughout the unonovesette portfolio. Constructed from AISI316L marine-grade stainless steel or aged solid brass with a hard anodized aluminium heatsink, and ingress protected to IP68. Explorer 65-2 renders an additional draining system as unnecessary.

*Explorer 65-2 è un proiettore a emissione radiale progettato per illuminare aree piane, ponti e percorsi. Explorer 65-2 offre a scelta fra tre temperature di colore come standard (2200K, 2700K, 3000K, 4000K) e garantisce 90 CRI per un'eccellente resa cromatica. LED binning-free due step Macadam's ellipses, assicurano consistenza del colore in tutte le versioni previste da unonovesette. Costruito in acciaio inossidabile AISI316L per uso marittimo o ottone massiccio invecchiato, un dissipatore di calore in alluminio anodizzato duro e un ingresso protetto IP68. Explorer 65-2 rende superfluo un ulteriore sistema di drenaggio.*

### TECHNICAL DATA / DATI TECNICI:

 IP68	 2200K / 2700K / 3000K / 4000K
 2W	 90°
 140 lm (3000K)	
 A++	 Smart Shield
 CRI >90	

### FINISHES / FINITURE:

	Stainless steel AISI316L Acciaio INOX AISI316L
	Machined aged solid brass Ottone anticato

### OPTICS / OTTICHE:

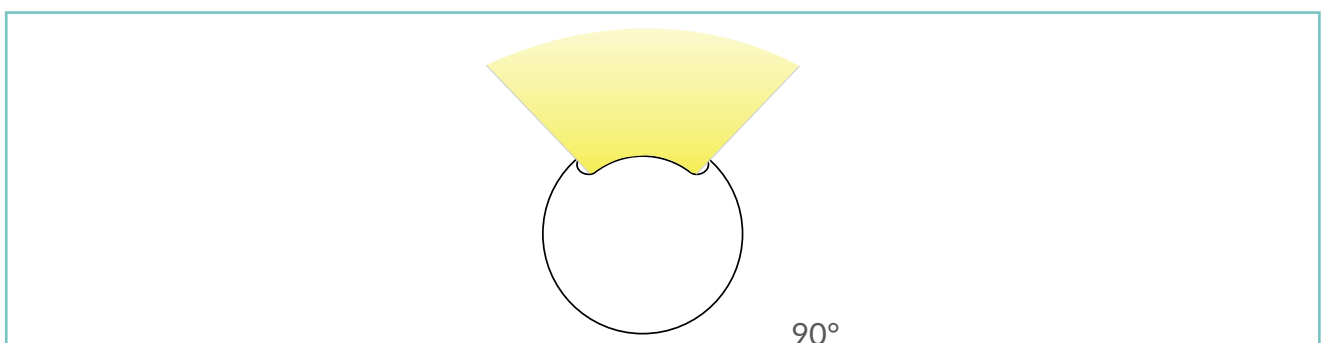

unonovasette



# unonovesette

## PRODUCT CODE / CODICE PRODOTTO:

	<b>E65-2=EXPLORER 65-2</b> Select one component from each column to specify a complete configuration: Selezionare un componente per ogni colonna per la configurazione completa:		
	LED colour / Colore LED	Optics / Ottiche	Finish / Finiture
	22 = 2200K 27 = 2700K 30 = 3000K 40 = 4000K	R = 90°	03 = Stainless steel AISI316L / Acciaio INOX AISI316L 10 = Aged solid brass/ Ottone anticato

Standard configuration example/  
 Esempio di configurazione standard: **E65-2.30.R.03 Explorer 65-2 3000K 90° optics stainless steel / Acciaio INOX**

## POWER SUPPLIES 24Vdc CONSTANT VOLTAGE / ALIMENTATORE TENSIONE COSTANTE 24Vdc:

On / Off

Code / Codice	Input	I Out	V Out	Watt	IP	#Explorer 65-2
PSU.CX.004	110+240V / 50/60 Hz	0,9 A	24Vdc	20	IP20	Max 8
PSU.CV.005	90+305V / 47/63 Hz	1 A	24Vdc	25	IP67	Max 10
PSU.CV.006	90+305V / 47/63 Hz	2,5 A	24Vdc	60	IP67	Max 25
PSU.CV.007	90+305V / 47/63 Hz	3,75 A	24Vdc	90	IP67	Max 36

Control gear / Elettronica di controllo

Code / Codice	Input	I Out	V Out	Watt	IP	#Explorer 65-2
CGE.004 - 0/1-10V	24Vdc	6,5 A	24Vdc	156	IP20	Max 70
CGE.017 - DALI	24Vdc	6,5 A	24Vdc	156	IP20	Max 70
CGE.017.IP - DALI	24Vdc	6,5 A	24Vdc	156	IP67	Max 70
CGE.020 - DMX	24Vdc	6,5 A	24Vdc	156	IP20	Max 70

## ACCESSORIES / ACCESSORI

	Housing Box Cassaforma HB.009 (70 g)		CV00037	Cable Cavo
			CV00040	5m
			CV00041	10m
			CV00042	15m
			CV00043	20m
				25m

## EXPLORER 65-2

TECHNICAL DRAWING / DISEGNO TECNICO:

RECESSED HOLE / FORO INCASSO:

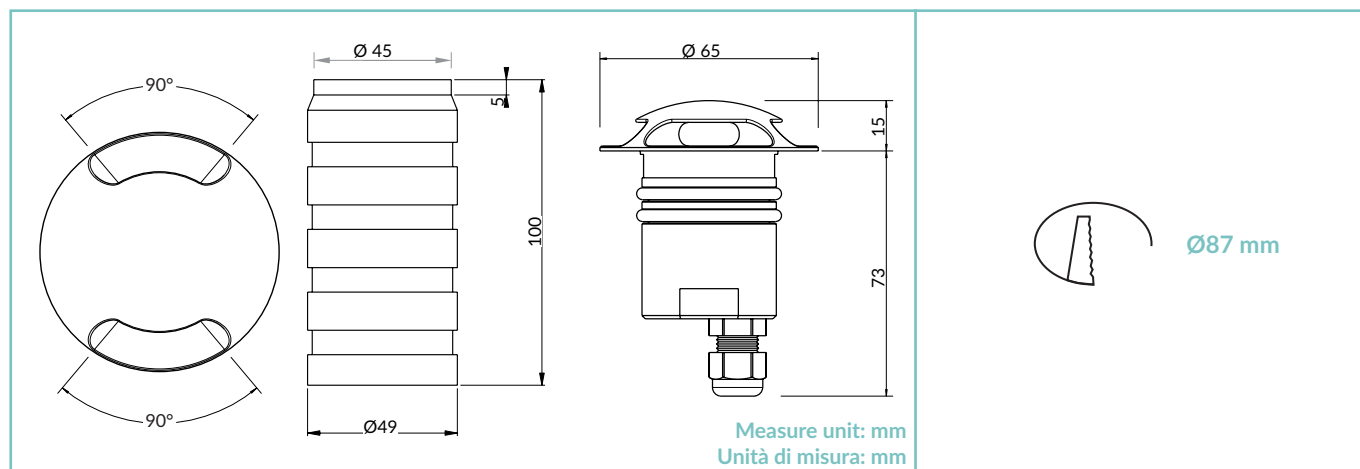

TECHNICAL SHEET / SCHEDA PRODOTTO:

Body:	Stainless Steel AISI316L - Anodized aluminium 6026 / Machined aged brass - Anodized aluminium 6026
Glass:	PMMA 3mm
Finishes:	Stainless Steel AISI316L / Aged solid brass
Installation:	Housing box
Power supply cables:	35 cm NS20N PCP 2x0,5 mm <sup>2</sup>
Power supply:	Constant voltage 24Vdc
Power consumption:	2 Watt
CRI:	>90
Bin selection:	Binning free 2 step MacAdam's
Lumen Output:	140 lm (3000K)
Operating temperature:	-20°C +50°C
IP rating:	IP68 (not for permanent immersion)
Insulation class:	Class III
Impact resistance:	IK08
Weight:	260 g
Optics:	90°
Energy rating:	A++
LED colour temperature:	2200K / 2700K / 3000K / 4000K
Lifetime LED:	100000 hrs
Photo biological risk:	RG0 / RG1
Static load resistance:	2500 Kg

Corpo:	Acciaio INOX AISI316L - Alluminio 6026 anodizzato / Ottone anticato - Alluminio 6026 anodizzato
Vetro:	PMMA 3mm
Finiture:	Acciaio INOX AISI316L / Ottone anticato
Fissaggio:	Cassaforma
Cavo di alimentazione:	35 cm NS20N PCP 2x0,5 mm <sup>2</sup>
Alimentazione:	Tensione costante 24Vdc
Potenza assorbita:	2 Watt
CRI:	>90
Selezione Bin:	Binning free 2 step MacAdam's
Flusso luminoso:	140 lm (3000K)
Temperatura di funzionamento:	-20°C +50°C
Grado di protezione:	IP68 (non per immersione permanente)
Classe d'isolamento:	Classe III
Protezione impatto:	IK08
Peso:	260 g
Ottiche:	90°
Energy rating:	A++
Temperatura colore LED:	2200K / 2700K / 3000K / 4000K
Vita media LED:	100000 hrs
Rischio fotobiologico:	RG0 / RG1
Carico statico:	2500 Kg

PHOTOMETRICS / CURVE FOTOMETRICHE:

90° - 2 Watt

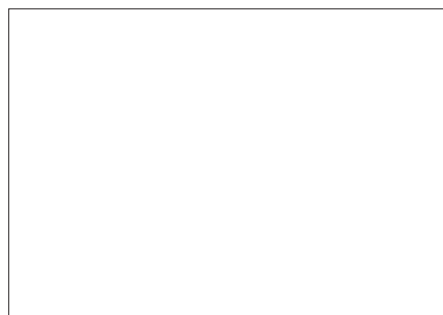

— C0 - C180 (10,0°)