









IP68

EXPLORER 125-1



Explorer 125-1 is a radial floor washer designed to light flat areas, decks and paths. Explorer 125-1 offers a choice of three colour temperatures as standard (2700K, 3000K, 4000K and RGBW) and delivers 90CRI for excellent colour rendering, and with binning-free LEDs carefully selected from two-step Macadam's ellipses, colour consistency is assured throughout the unonovesette portfolio. Constructed from AISI316L marine-grade stainless steel or aged solid brass with a hard anodized aluminium heatsink, and ingress protected to IP68. Explorer 125-1 renders an additional draining system as unnecessary.

Explorer 125-1 est un lave-plancher radial conçu pour éclairer les surfaces planes, les ponts et les chemins. Explorer 125-1 offre un choix de trois températures de couleur en standard (2700K, 3000K, 4000K et RGBW) et fournit 90 IRC pour un excellent rendu des couleurs, et avec des LED sans binning soigneusement sélectionnées parmi les ellipses de Macadam en deux étapes, la cohérence des couleurs est assurée partout le portefeuille unonovesette. Construit en acier inoxydable de qualité marine AISI316L ou en laiton vieilli avec un dissipateur thermique en aluminium anodisé dur et une protection contre la pénétration IP68.

TECHNICAL DATA / FICHE TECHNIQUE:

 IP68	 2700K / 3000K / 4000K
 5W / 9W	 20° / 90°
 515 lm / 730 lm (3000K)	 Smart Shield
 >90	
	

FINISHES / FINITIONS:

	Stone washed stainless steel AISI316L Acier INOX AISI316L lavé à la pierre
	Aged solid brass Laiton vieilli
	Pre-aged solid brass Laiton pre-vieilli

OPTICS / OPTIQUE:

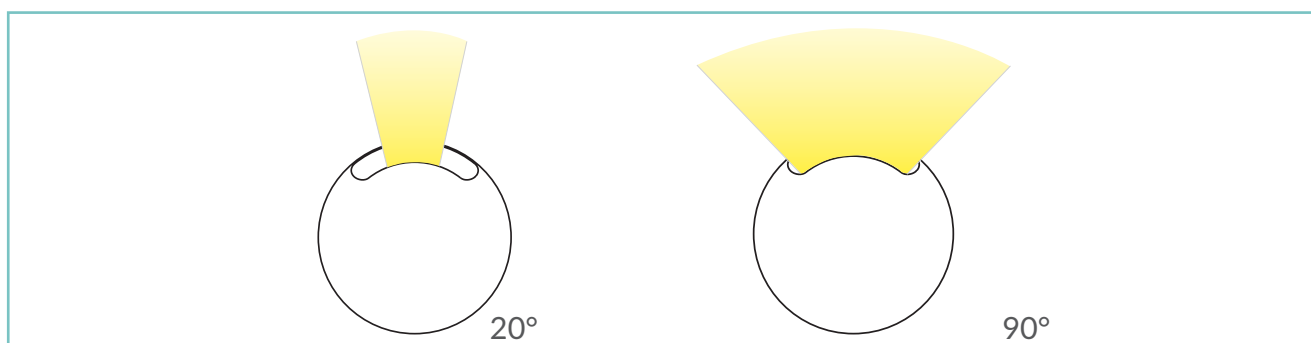

unonovasette



unonovasette

PRODUCT CODE/CODE PRODUIT:

E125-1 = EXPLORER 125-1

Select one component from each column to specify a complete configuration:
Sélectionner un composant pour chaque colonne pour une configuration complète:

LED colour / Couleur LED	Optics / Optique	Finish / Finitions	Power / Puissance
 27 = 2700K 30 = 3000K 40 = 4000K	 N = 20° R = 90°	 10 = Aged solid brass / Laiton vieilli 17 = Stone washed stainless steel AISI316L / Acier INOX AISI316L lavé à la pierre 21 = Pre-aged solid brass / Ottone pre-anticato	 05 = 5W 09 = 9W

Standard configuration example/
Exemple de configuration standard:

E125-1.30.N.17.09 Explorer 125-1 3000K 20° optics stone washed stainless steel / Acier INOX lavé à la pierre 9W

POWER SUPPLIES 24Vdc CONSTANT VOLTAGE / ALIMENTATEUR TENSION CONSTANTE 24Vdc:

On / Off 9W

Code / Code	Input	I Out	V Out	Watt	IP	#Explorer 125-1
PSU.CX.004	110+240V / 50/60 Hz	0,9 A	24Vdc	20	IP20	Max 2
PSU.CV.005	90+305V / 47/63 Hz	1 A	24Vdc	25	IP67	Max 2
PSU.CV.006	90+305V / 47/63 Hz	2,5 A	24Vdc	60	IP67	Max 6
PSU.CV.007	90+305V / 47/63 Hz	3,75 A	24Vdc	90	IP67	Max 8
PSU.CV.021	90+305V / 47/63 Hz	10 A	24Vdc	240	IP67	Max 20

Control gear / Système de control 9W

Code / Code	Input	I Out	V Out	Watt	IP	#Explorer 125-1
CGE.004 - 0/1-10V	24Vdc	6,5 A	24Vdc	156	IP20	Max 14
CGE.017 - DALI	24Vdc	6,5 A	24Vdc	156	IP20	Max 14
CGE.017.IP - DALI	24Vdc	6,5 A	24Vdc	156	IP67	Max 14
CGE.020 - DMX	24Vdc	6,5 A	24Vdc	156	IP20	Max 14

ACCESSORIES / ACCESSOIRES

 Housing box Boîtier d'encastrement HB.012 (386g)	 Cable Câble 5m 10m 15m 20m 25m
	CV00037 CV00040 CV00041 CV00042 CV00043

EXPLORER 125-1

TECHNICAL DRAWING / DESSIN TECHNIQUE:

RECESSED HOLE / TROU D'ENCASTREMENT:

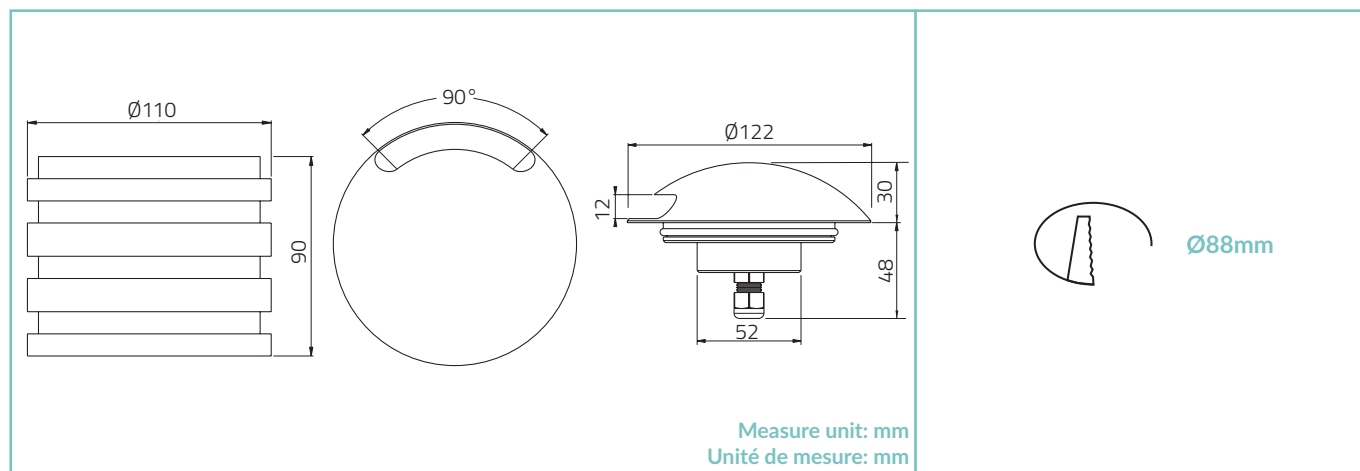

TECHNICAL SHEET / FICHE PRODUIT:

Body:	Stainless Steel AISI316L - Anodized aluminium 6026 / Solid brass - Anodized aluminium 6026
Glass:	Tempered extra clear 4mm
Finishes:	Stone washed stainless Steel AISI316L / Aged solid brass / Pre-aged solid brass
Installation:	Housing box
Power supply cables:	35cm NS20N PCP 2x0,5mm ²
Power supply:	Constant voltage 24Vdc
Power consumption:	5 Watt / 9 Watt
CRI:	>90
Bin selection:	Binning free 2 step MacAdam's
Lumen output (source):	515 lm / 730 lm (3000K)
Lumen output (delivered):	250 lm / 360 lm (3000K)
Operating temperature:	-20°C +50°C
IP rating:	IP68 (not for permanent immersion)
Insulation class:	Class III
Impact resistance:	IK10
Weight:	1,2kg
Optics:	20° / 90°
LED colour temperature:	2700K / 3000K / 4000K
Lifetime LED:	50000h L95 B10 (Ta 25°C)
Photo biological risk:	RG0 / RG1
Static load resistance:	2500 Kg

Corps:	Acier INOX AISI316L - Alluminium 6026 anodisé / Laiton - Alluminium 6026 anodisé
Verre:	Verre trempé extra clair 4mm
Finitions:	Acier INOX AISI316L lavé à la pierre / Laiton vieilli / Laiton pre-veilli
Installation:	Boîtier d'encastrement
Câbles d'alimentation:	35cm NS20N PCP 2x0,5mm ²
Alimentation:	Tension constante 24Vdc
Puissance absorbée:	5 Watt / 9 Watt
IRC Indice de Rendu des Couleurs:	>90
Sélection du bin:	Binning free 2 step MacAdam's
Flux lumineux (source):	515 lm / 730 lm (3000K)
Flux lumineux (sortant):	250 lm / 360 lm (3000K)
Température de fonctionnement:	-20°C +50°C
Indice de protection:	IP68 (pas en immersion permanente)
Classe d'isolation:	Classe III
Indice de résistance:	IK08
Poids:	1,2kg
Optiques:	20° / 90°
LED colour temperature:	2700K / 3000K / 4000K
Durée moyenne LED:	50000h L95 B10 (Ta 25°C)
Sécurité photobiologique:	RG0 / RG1
Carico statico:	2500 Kg

PHOTOMETRICS / COURVES PHOTOMETRIQUE:

90° - 9 Watt

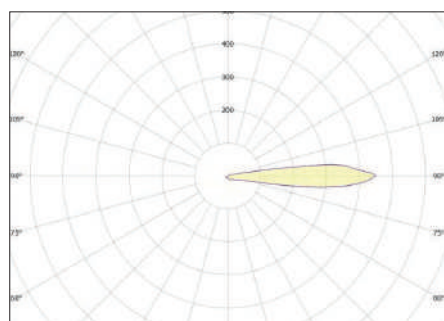

— C0 - C180 (40,0°)