











IP68

CALIBER 80



Caliber 80 is an extremely efficient compact in-ground LED uplight, designed for optical excellence and engineered for complete resilience. Caliber 80 offers a choice of three colour temperatures as standard (2700K, 3000K and 4000K) and delivers 90CRI for excellent colour rendering, and with binning-free LEDs carefully selected from two-step MacAdam's ellipses, colour consistency is assured throughout the unonovesette portfolio. With a deep recess of the in-house designed PCB, Caliber 80 offers excellent glare control.

Caliber 80 è un apparecchio a LED dalle dimensioni compatte da incasso a pavimento ed estremamente efficiente. Ideato con un'ottica eccellente e progettato per una completa flessibilità. Caliber 80 offre una scelta fra tre temperature di colore come standard (2700K, 3000K e 4000K) tutte con CRI maggiore di 90 per una eccellente resa cromatica. Binning-free e due-step MacAdam's ellipses LED, assicurano consistenza del colore in tutte le versioni previste da unonovesette. Con l'elettronica progettata internamente e ben posizionata, Caliber 80 offre un eccellente controllo dell'abbagliamento.

TECHNICAL DATA / DATI TECNICI:

-  IP68
-  5W / 9W
-  515 lm / 730 lm (3000K)
-  A++
-  CRI >90
-  2700K / 3000K / 4000K / RGBW
-  10° / 30° / 50° / 10°x45° / (35° RGBW)
-  CE
-  Smart Shield

FINISHES / FINITURE:

-  Stainless steel AISI316L
Acciaio INOX AISI316L
-  Machined aged solid brass
Ottone anticato

OPTICS / OTTICHE:

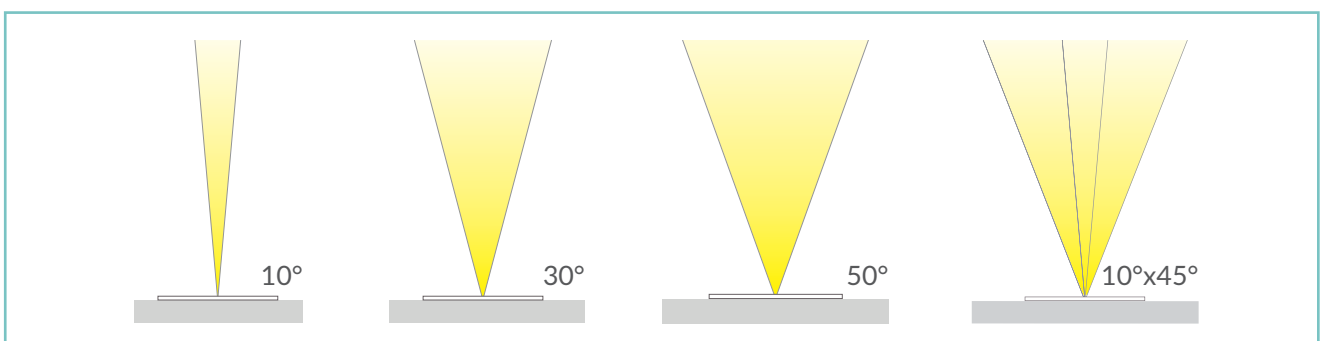



unonovesette

PRODUCT CODE / CODICE PRODOTTO:

C80 = CALIBER 80		Select one component from each column to specify a complete configuration: Selezionare un componente per ogni colonna per la configurazione completa:			
		LED colour / Colore LED	Optics / Ottiche	Finish / Finiture	Watt
		27 = 2700K 30 = 3000K 40 = 4000K FC = RGBW	N = 10° M = 30° (35° RGBW) W = 50° E = 10°x 45° S = Satin/Satinato	03 = Stainless steel AISI316L / Acciaio INOX AISI316L 10 = Aged Brass/ Ottone anticato	05 = 5 W 09 = 9 W

Standard configuration example/
Esempio di configurazione standard:

C80.30.N.03.09 Caliber 80 3000K 10° optics stainless steel / Acciaio INOX 9 Watt

POWER SUPPLIES 24Vdc CONSTANT VOLTAGE / ALIMENTATORE TENSIONE COSTANTE 24Vdc:







On / Off

Code / Codice	Input	I Out	V Out	Watt	IP	#Caliber 80
PSU.CX.004	110+240V / 50/60 Hz	0,9 A	24Vdc	20	IP20	Max 2
PSU.CV.005	90+305V / 47/63 Hz	1 A	24Vdc	25	IP67	Max 2
PSU.CV.006	90+305V / 47/63 Hz	2,5 A	24Vdc	60	IP67	Max 6
PSU.CV.007	90+305V / 47/63 Hz	3,75 A	24Vdc	90	IP67	Max 8

Control gear / Elettronica di controllo

Code / Codice	Input	I Out	V Out	Watt	IP	#Caliber 80
CGE.004 - 0/1-10V	24Vdc	6,5 A	24Vdc	156	IP20	Max 15
CGE.017 - DALI	24Vdc	6,5 A	24Vdc	156	IP20	Max 15
CGE.017.IP - DALI	24Vdc	6,5 A	24Vdc	156	IP67	Max 15
CGE.020 - DMX	24Vdc	6,5 A	24Vdc	156	IP20	Max 15

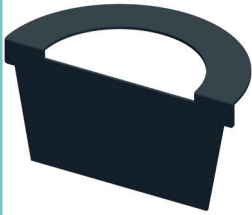
ACCESSORIES / ACCESSORI

					
Housing Box Cassaforma HB.003 (170 g)	Housing Box Cassaforma HB.014 (320 g)	Fixing springs Molle di fissaggio ACC.007	Honeycomb louver Schermo alveolare ACC.004	Anti-Glare louver Frangiluce ACC.009	Cable Cavo CV00037 5m CV00040 10m CV00041 15m CV00042 20m CV00043 25m

TECHNICAL DRAWING / DISEGNO TECNICO:

RECESSED HOLE / FORO INCASSO:

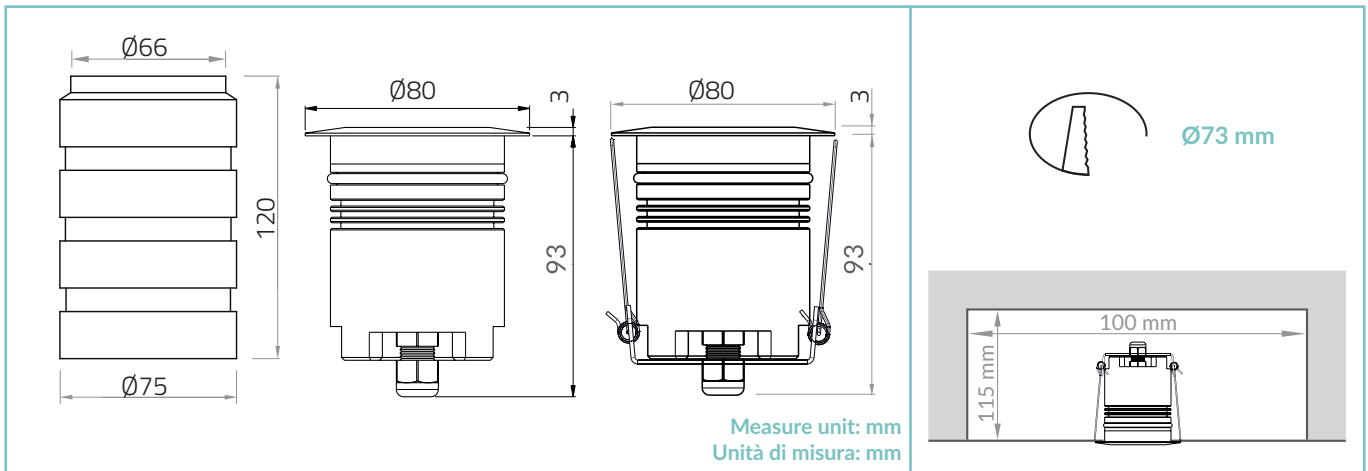

TECHNICAL SHEET / SCHEDA PRODOTTO:

Body: Stainless Steel AISI316L - Anodized aluminium 6026 / Machined aged brass - Anodized aluminium 6026

Glass: Tempered extra clear / frosted glass 6 mm

Finishes: Stainless Steel AISI316L / Aged solid brass

Installation: Housing box / Fixing Springs

Power supply cables: 35 cm NS20N PCP 2x0,5 mm²

Power supply: Constant voltage 24Vdc

Power consumption: 5 Watt / 9 Watt

CRI: >90

Bin selection: Binning free 2 step MacAdam's

Lumen Output: 515 lm / 730 lm (3000K)

Operating temperature: -20°C +50°C

IP rating: IP68 (not for permanent immersion)

Insulation class: Class III

Impact resistance: IK08

Weight: 570 g

Optics: 10° / 30° / 50° / 10°x45° / (35° RGBW)

Energy rating: A++

LED colour temperature: 2700K / 3000K / 4000K / RGBW

Lifetime LED: 100000 hrs

Photo biological risk: RGO / RG1

Corpo: Acciaio INOX AISI316L - Alluminio 6026 anodizzato / Ottone anticato - Alluminio 6026 anodizzato

Vetro: Vetro temperato extra chiaro / satinato 6 mm

Finiture: Acciaio INOX AISI316L / Ottone anticato

Fissaggio: Cassaforma / Molle di fissaggio

Cavo di alimentazione: 35 cm NS20N PCP 2x0,5 mm²

Alimentazione: Tensione costante 24Vdc

Potenza assorbita: 5 Watt / 9 Watt

CRI: >90

Selezione bin: Binning free 2 step MacAdam's

Flusso luminoso: 515 lm / 730 lm (3000K)

Temperatura di funzionamento: -20°C +50°C

Grado di protezione: IP68 (non per immersione permanente)

Classe d'isolamento: Classe III

Protezione impatto: IK08

Peso: 570 g

Ottiche: 10° / 30° / 50° / 10°x45° / (35° RGBW)

Energy rating: A++

Temperatura colore LED: 2700K / 3000K / 4000K / RGBW

Vita media LED: 100000 hrs

Rischio fotobiologico: RGO / RG1

PHOTOMETRICS/CURVE FOTOMETRICHE:

10° - 9 Watt

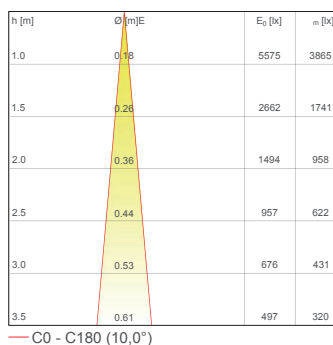

30° - 9 Watt

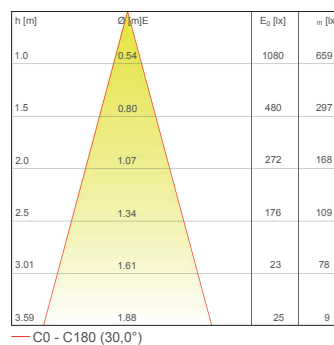

50° - 9 Watt

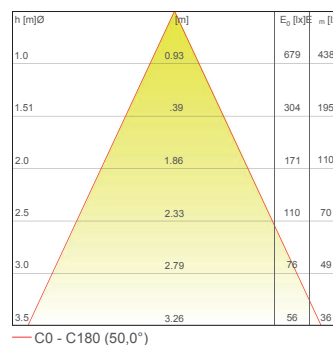

10°x45° - 9 Watt

