













IP68

CALIBER 80 HV



Caliber 80 HV is an extremely efficient compact in-ground LED up-light directly powered on Line Voltage, designed for optical excellence and engineered for complete resilience. Caliber 80 HV offers a choice of three colour temperatures as standard (2700K, 3000K and 4000K) and delivers 90 CRI for excellent colour rendering, and with binning-free LEDs carefully selected from two-step MacAdam's ellipses, colour consistency is assured throughout the unonovesette portfolio. With a deep recess of the in-house designed PCB, Caliber 80 HV offers excellent glare control.

Caliber 80HV è un apparecchio a LED dalle dimensioni compatte da incasso a pavimento ed estremamente efficiente, alimentato direttamente con la tensione di rete, ideato con un'ottica eccellente e progettato per una completa flessibilità. Caliber 80HV offre una scelta fra tre temperature di colore come standard (2700K, 3000K e 4000K) tutte con CRI maggiore di 90 per una eccellente resa cromatica. Binning-free e due-step MacAdam's ellipses LED, assicurano consistenza del colore in tutte le versioni previste da unonovesette. Con l'elettronica progettata internamente e ben posizionata, Caliber 80HV offre un eccellente controllo dell'abbagliamento.

TECHNICAL DATA / DATI TECNICI:

 IP68	 2700K / 3000K / 4000K
 6W	 10° / 30° / 50° / 10°x45° / Satin
 540 lm (3000K)	
 A++	 Smart Shield
 >90	 Vac 100-240 50/60Hz

FINISHES / FINITURE:

	Stainless steel AISI316L Acciaio INOX AISI316L
	Machined aged solid brass Ottone anticato

OPTICS / OTTICHE:

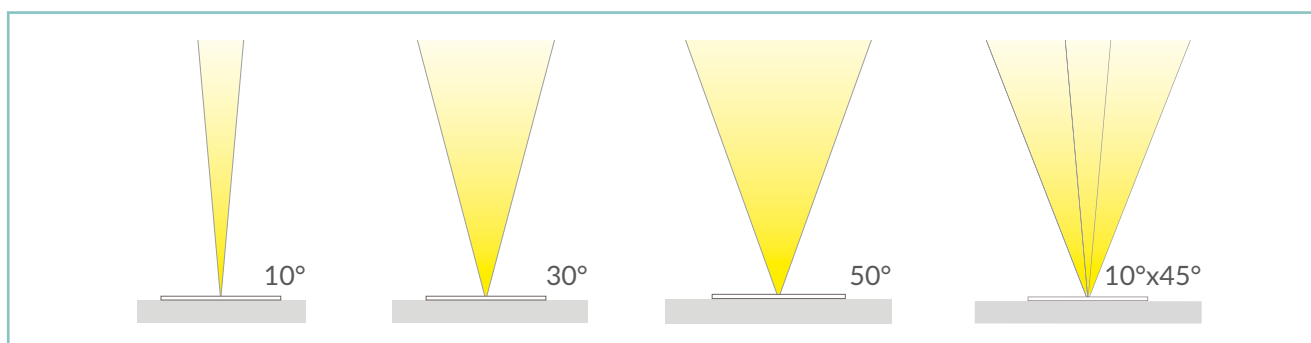

unonovesette



unonovesette



PRODUCT CODE / CODICE PRODOTTO:

C8H = CALIBER 80HV		Select one component from each column to specify a complete configuration: <i>Selezionare un componente per ogni colonna per la configurazione completa:</i>		
		LED colour / Colore LED	Optics / Ottiche	Finish / Finiture
		27 = 2700K 30 = 3000K 40 = 4000K	N = 10° M = 30° W = 50° E = 10°x 45° S = Satin/Satinato	03 = Stainless steel AISI316L / Acciaio INOX AISI316L 10 = Aged Brass/ Ottone anticato

Standard configuration example/
Esempio di configurazione standard:

C8H.30.N.03 Caliber 80 HV 3000K 10° optics stainless steel / Acciaio INOX

ACCESSORIES / ACCESSORI

 <p>Housing Box <i>Cassaforma</i> HB.006 (270 g)</p>	 <p>Honeycomb louver <i>Schermo alveolare</i> ACC.004</p>	 <p>Anti-Glare louver <i>Frangiluce</i> ACC.073</p>
---	--	--

TECHNICAL DRAWING / DISEGNO TECNICO:

RECESSED HOLE / FORO INCASSO:

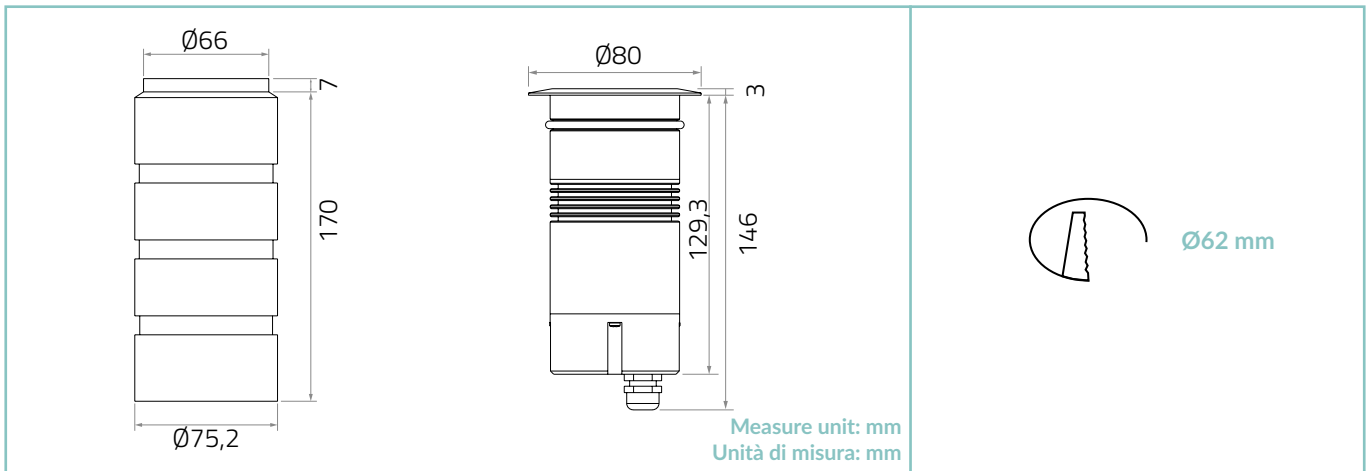

TECHNICAL SHEET / SCHEDA PRODOTTO:

Body: Stainless Steel AISI316L - Anodized aluminium 6026 / Machined aged brass - Anodized aluminium 6026

Glass: Tempered extra clear / frosted glass 6 mm

Finishes: Stainless Steel AISI316L / Aged solid brass

Installation: Housing box

Power supply cables: 35 cm H05RNF PCP 3x0,5 mm²

Power supply: 100-240 Vac 50/60Hz

Power consumption: 6 Watt

CRI: >90

Bin selection: Binning free 2 step MacAdam's

Lumenoutput (source): 540 lm (3000K)

Operating temperature: -20°C +50°C

IP rating: IP68 (not for permanent immersion)

Insulation class: Class I

Impact resistance: IK08

Weight: 640 g

Optics: 10° / 30° / 50° / 10°x 45° / Satin

Energy rating: A++

LED colour temperature: 2700K / 3000K / 4000K

Lifetime LED: 100000 hrs

Photo biological risk: RGO / RG1

Corpo: Acciaio INOX AISI316L - Alluminio 6026 anodizzato / Ottone anticato - Alluminio 6026 anodizzato

Vetro: Vetro temperato extra chiaro o satinato 6 mm

Finiture: Acciaio INOX AISI316L / Ottone anticato

Fissaggio: Cassaforma

Cavo di alimentazione: 35 cm H05RNF PCP 3x0,5 mm²

Alimentazione: 100-240 Vac 50/60Hz

Potenza assorbita: 6 Watt

CRI: >90

Selezione bin: Binning free 2 step MacAdam's

Flusso luminoso (sorgente): 540 lm (3000K)

Temperatura di funzionamento: -20°C +50°C

Grado di protezione: IP68 (non per immersione permanente)

Classe d'isolamento: Classe I

Protezione impatto: IK08

Peso: 640 g

Ottiche: 10° / 30° / 50° / 10°x 45° / Satinato

Energy rating: A++

Temperatura colore LED: 2700K / 3000K / 4000K

Vita media LED: 100000 hrs

Rischio fotobiologico: RGO / RG1

PHOTOMETRICS/CURVE FOTOMETRICHE:

10° - 6 Watt

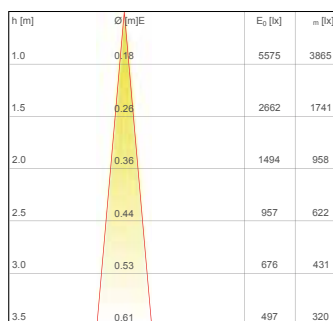

30° - 6 Watt

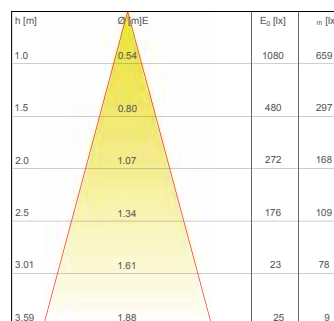

50° - 6 Watt

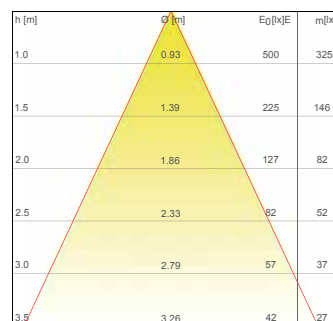

10°x45° - 6 Watt

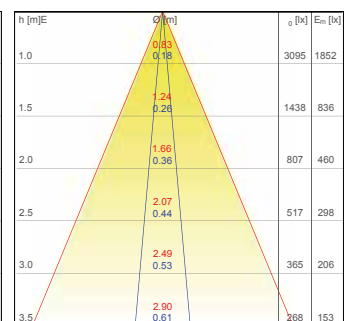

— C0 - C180 (10,0°)

— C0 - C180 (30,0°)

— C0 - C180 (50,0°)

— C0 - C180 (45,0°) — C90 - C270 (10,0°)