



IP68

## CALIBER 80

Caliber 80 is an extremely efficient compact in-ground LED uplight, designed for optical excellence and engineered for complete resilience. Caliber 80 offers a choice of three colour temperatures as standard (2700K, 3000K and 4000K) and delivers 90CRI for excellent colour rendering, and with binning-free LEDs carefully selected from two-step MacAdam's ellipses, colour consistency is assured throughout the unonovesette portfolio. With a deep recess of the in-house designed PCB, Caliber 80 offers excellent glare control.

*Caliber 80 est un luminaire à LED compact, à encastrer au sol et très efficace. Conçu avec d'excellentes optiques et pour une flexibilité complète. Le Caliber 80 incorpore le système Smart Shield, ainsi qu'un driver en courant constant intégré qui permet d'alimenter le luminaire en parallèle avec une alimentation à tension constante de 24 Vdc. Facilement dimmable avec les systèmes DALI ou DMX en 24Vdc.*

*Un boîtier d'encastrement ou des Ressorts de montage sont disponibles pour faciliter l'installation au sol. Avec une électronique conçue en interne et bien positionnée, le Caliber 80 offre un excellent contrôle de l'éblouissement.*

### TECHNICAL DATA / FICHE TECHNIQUE:

 IP68

 5W / 9W

 515 lm / 730 lm (3000K)

 A++

 CRI >90

 2700K / 3000K / 4000K / RGBW

 10° / 30° / 50° / 10°x45° / (35° RGBW)

 CE

 Smart Shield

### FINISHES / FINITIONS:

 Stainless steel AISI316L  
Acier INOX AISI316L

 Machined aged solid brass  
Laiton vieilli

### OPTICS / FAISCEAU:

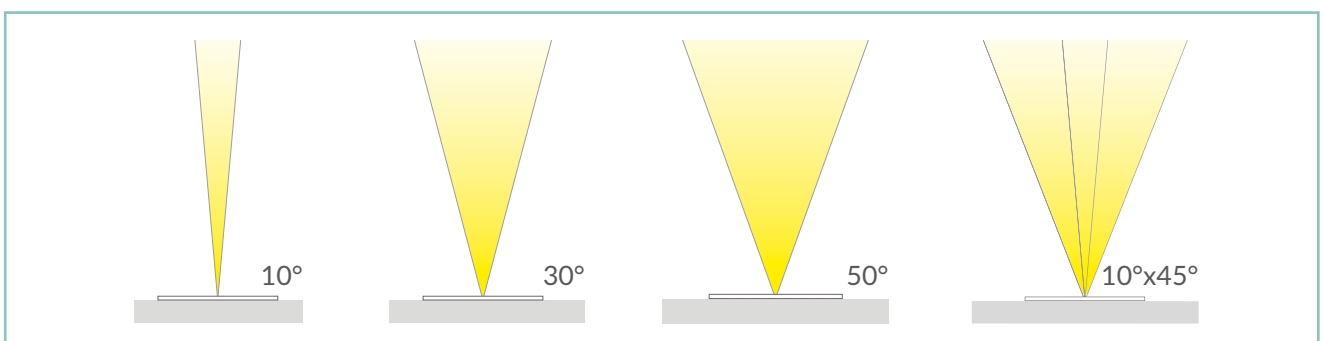

unonovasette



# unonovesette

## PRODUCT CODE/CODE PRODUIT:

<b>C80 = CALIBER 80</b> 	Select one component from each column to specify a complete configuration: <i>Sélectionner un composant pour chaque colonne pour une configuration complète:</i>			
	LED colour / Couleur LED	Optics / Faisceau	Finish / Finitions	Watt
27 = 2700K 30 = 3000K 40 = 4000K FC = RGBW	N = 10° M = 30° (35° RGBW) W = 50° E = 10°x 45° S = Satin/Satiné	03 = Stainless steel AISI316L / Acier INOX AISI316L 10 = Aged Brass / Laiton vieilli	05 = 5 W 09 = 9 W	

Standard configuration example/  
 Exemple de configuration standard:

**C80.30.N.03.09** Caliber 80 3000K 10° optics stainless steel / Acier INOX 9 Watt

## POWER SUPPLIES 24Vdc CONSTANT VOLTAGE / ALIMENTATEUR TENSION CONSTANTE 24Vdc:





On / Off

Code / Code	Input	I Out	V Out	Watt	IP	#Caliber 80
PSU.CX.004	110+240V / 50/60 Hz	0,9 A	24Vdc	20	IP20	Max 2
PSU.CV.005	90+305V / 47/63 Hz	1 A	24Vdc	25	IP67	Max 2
PSU.CV.006	90+305V / 47/63 Hz	2,5 A	24Vdc	60	IP67	Max 6
PSU.CV.007	90+305V / 47/63 Hz	3,75 A	24Vdc	90	IP67	Max 8

Control gear / Système de control

Code / Code	Input	I Out	V Out	Watt	IP	#Caliber 80
CGE.004 - 0/1-10V	24Vdc	6,5 A	24Vdc	156	IP20	Max 15
CGE.017 - DALI	24Vdc	6,5 A	24Vdc	156	IP20	Max 15
CGE.017.IP - DALI	24Vdc	6,5 A	24Vdc	156	IP67	Max 15
CGE.020 - DMX	24Vdc	6,5 A	24Vdc	156	IP20	Max 15

## ACCESSORIES / ACCESSOIRES

 Housing Box Boîtier d'encastrement HB.003 (170 g)	 Fixing springs Ressorts de montage ACC.007	 Honeycomb louver Grille nid d'abeille ACC.004	 Anti-Glare louver Visière anti-éblouissement ACC.073	 Cable Câble CV00037 5m CV00040 10m CV00041 15m CV00042 20m CV00043 25m
--	---	--	--	---

TECHNICAL DRAWING / DESSIN TECHNIQUE:

RECESSED HOLE / TROU D'ENCASTREMENT:

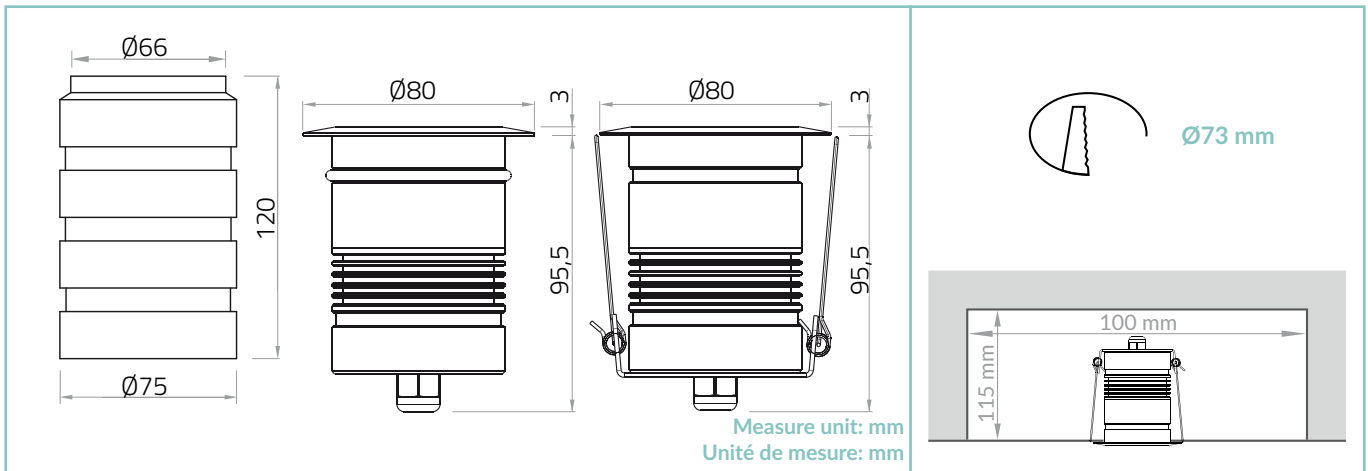

TECHNICAL SHEET / FICHE PRODUIT:

**Body:** Stainless Steel AISI316L - Anodized aluminium 6026 / Machined aged brass - Anodized aluminium 6026

**Glass:** Tempered extra clear / frosted 6 mm

**Finishes:** Stainless Steel AISI316L / Aged solid brass

**Installation:** Housing box / Fixing Springs

**Power supply cables:** 35 cm NS20N PCP 2x0,5 mm<sup>2</sup>

**Power supply:** Constant voltage 24Vdc

**Power consumption:** 5 Watt / 9 Watt

**CRI:** >90

**Bin selection:** Binning free 2 step MacAdam's

**Lumen Output:** 515 lm / 730 lm (3000K)

**Operating temperature:** -20°C +50°C

**IP rating:** IP68 (not for permanent immersion)

**Insulation class:** Class III

**Impact resistance:** IK08

**Weight:** 570 g

**Optics:** 10° / 30° / 50° / 10°x45° / (35° RGBW)

**Energy rating:** A++

**LED colour temperature:** 2700K / 3000K / 4000K / RGBW

**Lifetime LED:** 100000 hrs

**Photo biological risk:** RGO / RG1

**Corps:** Acier INOX AISI316L - Alluminium 6026 anodisé / Laiton vieilli - Alluminium 6026 anodisé

**Verre:** Verre temperé extra clair / satiné 6 mm

**Finitions:** Acier INOX AISI316L / Laiton vieilli

**Installation:** Boîtier d'encastrement / Ressorts de montage

**Câbles d'alimentation:** 35 cm NS20N PCP 2x0,5 mm<sup>2</sup>

**Alimentation:** Tension constante 24Vdc

**Puissance absorbée:** 5 Watt / 9 Watt

**IRC Indice de Rendu des Couleurs:** >90

**Sélection du bin:** Binning free 2 step MacAdam's

**Flux lumineux:** 515 lm / 730 lm (3000K)

**Température de fonctionnement:** -20°C +50°C

**Indice de protection:** IP68 (pas en immersion permanente)

**Classe d'isolation:** Classe III

**Indice de résistance:** IK08

**Poids:** 570 g

**Optiques:** 10° / 30° / 50° / 10°x45° / (35° RGBW)

**Classe d'efficacité énergétique:** A++

**Couleur LED:** 2700K / 3000K / 4000K / RGBW

**Durée moyenne LED:** 100000 hrs

**Sécurité photobiologique:** RGO / RG1

PHOTOMETRICS / COURVES PHOTOMETRIQUE:

10° - 9 Watt

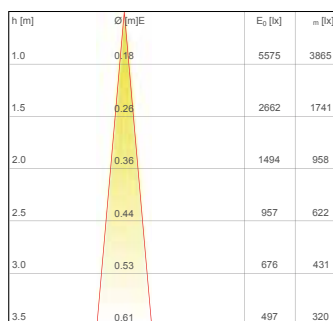

30° - 9 Watt

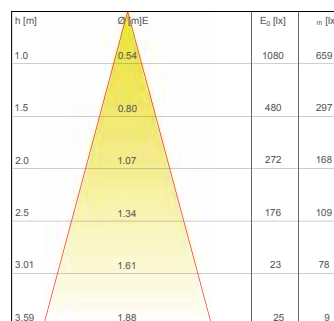

50° - 9 Watt

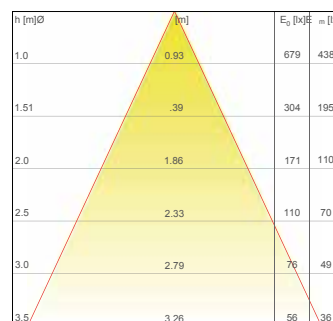

10°x45° - 9 Watt

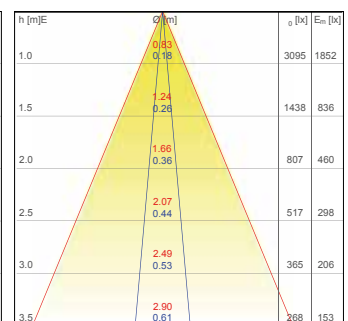

— C0 - C180 (10,0°)

— C0 - C180 (30,0°)

— C0 - C180 (50,0°)

— C0 - C180 (45,0°) — C90 - C270 (10,0°)