



IP68



CALIBER 55 SUB

Caliber 55 sub is an extremely efficient compact underwater recessed LED projector, designed for optical excellence and engineered for complete resilience. Caliber 55 sub offers a choice of four colour temperatures as standard (2200K, 2700K, 3000K and 4000K) and delivers 90 CRI for excellent colour rendering, and with binning-free LEDs carefully selected from two-step MacAdam's ellipses, colour consistency is assured throughout the unonovesette portfolio. With a deep recess of the in-house designed PCB, Caliber 55 sub offers excellent glare control.

Le Caliber 55 sub est un luminaire à LED compact, pour l'immersion jusqu'à 5 mètres de profondeur et très efficace. Il est conçu avec d'excellentes optiques et pour une flexibilité complète. Le Caliber 55 sub donne un choix de 4 températures de couleur 2200/2700/3000/4000K avec IRC >90 pour une excellente constance chromatique. Binning-free et 2 step MacAdam garantissent la cohérence des couleurs dans toutes les versions fournies par unonovesette. Avec une électronique conçue en interne et bien positionnée, le Caliber 55 sub offre un excellent contrôle de l'éblouissement.

TECHNICAL DATA / FICHE TECHNIQUE:

 IP68

 2W

 140 lm (3000K)

 >90



 2200K / 2700K / 3000K / 4000K

 10° / 23° / 43° / 10°x40°

 Smart Shield

FINISHES / FINITIONS:

 Stainless steel electropolished AISI316L
Acier INOX électropoli AISI316L

OPTICS / FAISCEAU:

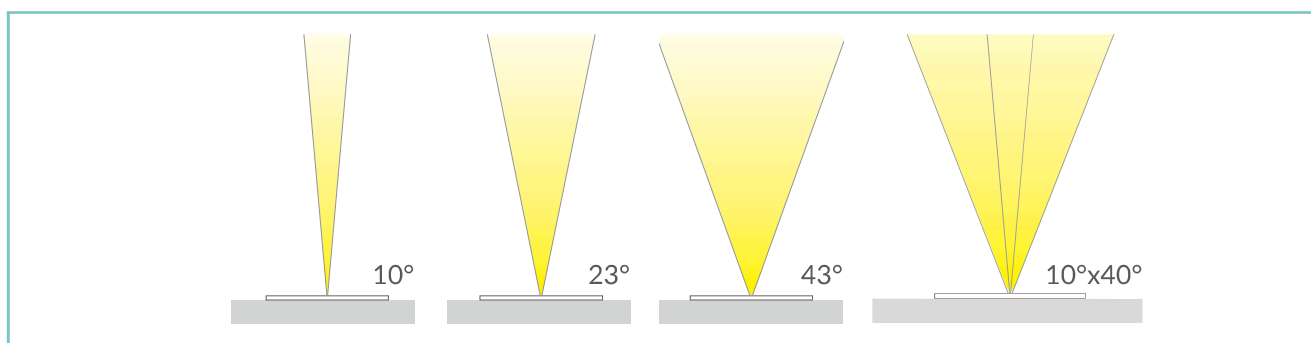

unonovasette



unonovesette

PRODUCT CODE/CODE PRODUIT:

C55 = CALIBER 55 SUB 	Select one component from each column to specify a complete configuration: <i>Sélectionner un composant pour chaque colonne pour une configuration complète:</i>		
	LED colour / Couleur LED	Optics / Faisceau	Finish / Finitions
22 = 2200K 27 = 2700K 30 = 3000K 40 = 4000K	N = 10° M = 23° W = 43° E = 10°x40°	12 = Stainless steel electropolished AISI316L / Acciaio INOX électropoli AISI316L	

Standard configuration example/
Exemple de configuration standard:

C55.30.N.12 Caliber 55 SUB 3000K 10° optics stainless steel / Acier INOX

POWER SUPPLIES 24Vdc CONSTANT VOLTAGE / ALIMENTATEUR TENSION CONSTANTE 24Vdc:





On / Off

Code / Code	Input	I Out	V Out	Watt	IP	#Caliber 55 sub
PSU.CX.004	110+240V / 50/60 Hz	0,9 A	24Vdc	20	IP20	Max 8
PSU.CV.005	90+305V / 47/63 Hz	1 A	24Vdc	25	IP67	Max 9
PSU.CV.006	90+305V / 47/63 Hz	2,5 A	24Vdc	60	IP67	Max 25
PSU.CV.007	90+305V / 47/63 Hz	3,75 A	24Vdc	90	IP67	Max 36
PSU.CV.021	90+305V / 47/63 Hz	10 A	24Vdc	240	IP67	Max 80

Control gear / *Système de control*

Code / Code	Input	I Out	V Out	Watt	IP	#Caliber 55 sub
CGE.004 - 0/1-10V	24Vdc	6,5 A	24Vdc	156	IP20	Max 70
CGE.017 - DALI	24Vdc	6,5 A	24Vdc	156	IP20	Max 70
CGE.017.IP - DALI	24Vdc	6,5 A	24Vdc	156	IP67	Max 70
CGE.020 - DMX	24Vdc	6,5 A	24Vdc	156	IP20	Max 70

ACCESSORIES / ACCESSOIRES

 <p>Housing Box <i>Boîtier d'encastrement</i> HB.009 (70 g)</p>	 <p>Honeycomb louver <i>Grille nid d'abeille</i> ACC.084</p>	 <p>Anti-Glare louver <i>Visière anti-éblouissement</i> ACC.008</p>	 <p>Cable <i>Câble</i> CV00040 10m CV00041 15m CV00042 20m CV00043 25m</p>
--	---	---	--

CALIBER 55 SUB

TECHNICAL DRAWING / DESSIN TECHNIQUE:

RECESSED HOLE / TROU D'ENCASTREMENT:

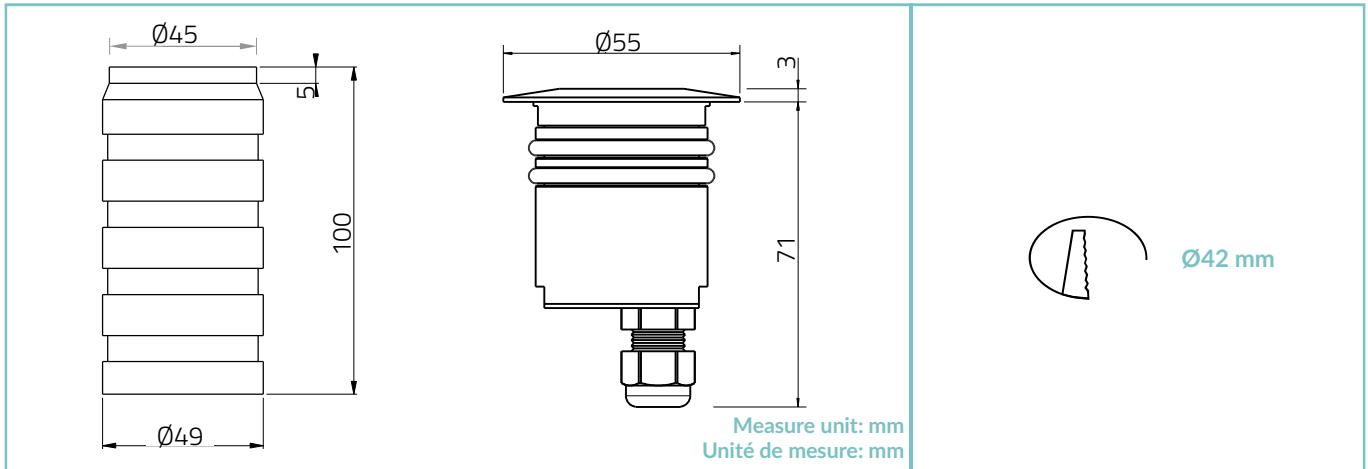

TECHNICAL SHEET / FICHE PRODUIT:

Body: Machined, electropolished stainless steel AISI316L
Glass: Extra clear 4mm tempered glass
Finishes: Electropolished stainless steel AISI316L
Installation: Housing box
Power supply cables: 500cm NS20N PCP 2x0,5 mm²
Power supply: Constant voltage 24Vdc
Power consumption: 2 Watt
CRI: >90
Bin selection: Binning free 2 step MacAdam's
Lumenoutput (source): 140 lm (3000K)
Operating temperature: -20°C +50°C
IP rating: IP68 (5 meter underwater)
Insulation class: Class III
Impact resistance: IK08
Weight: 600 g
Optics: 10° / 23° / 43° / 10°X40°
LED colour temperature: 2200K / 2700K / 3000K / 4000K
Lifetime LED: 100000 hrs
Photo biological risk: RGO / RG1

Corps: Acier inoxydable AISI316L electropoli
Verre: Verre temperé extra clair 4 mm
Finitions: Acier inoxydable electropoli AISI316L
Installation: Boîtier d'encastrement
Câbles d'alimentation: 500cm NS20N PCP 2x0,5 mm²
Alimentation: Tension constante 24Vdc
Puissance absorbée: 2 Watt
IRC Indice de Rendu des Couleurs: >90
Sélection du bin: Binning free 2 step MacAdam's
Flux de la source: 140 lm (3000K)
Température de fonctionnement: -20°C +50°C
Indice de protection: IP68 (5 mètres sous l'eau)
Classe d'isolation: Classe III
Indice de résistance: IK08
Poids: 600 g
Optiques: 10° / 23° / 43° / 10°X40°
Couleur LED: 2200K / 2700K / 3000K / 4000K
Durée moyenne LED: 100000 hrs
Sécurité photobiologique: RGO / RG1

PHOTOMETRICS / COURVES PHOTOMETRIQUE:

10° - 2 Watt

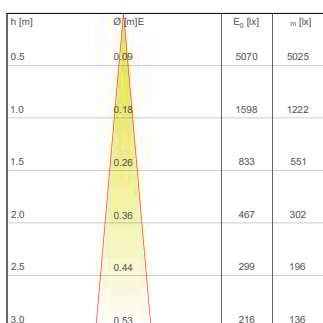

23° - 2 Watt

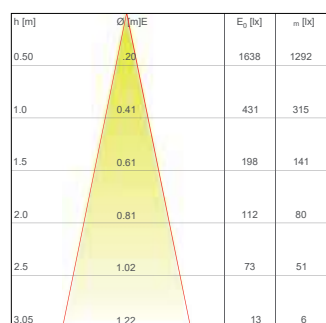

43° - 2 Watt

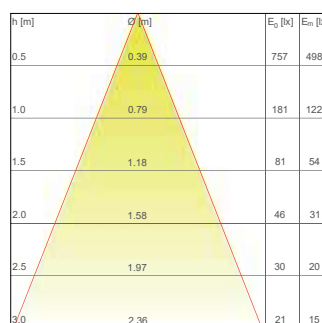

10°x40° - 2 Watt

