











IP68

CALIBER 52



Caliber 52 is an extremely efficient compact in-ground LED up-light, designed for optical excellence and engineered for complete resilience. Caliber 52 offers a choice of four colour temperatures as standard (2200K, 2700K, 3000K and 4000K) and delivers 90 CRI for excellent colour rendering, and with binning-free LEDs carefully selected from two-step MacAdam's ellipses, colour consistency is assured throughout the unonovesette portfolio. With a deep recess of the in-house designed PCB, Caliber 52 offers excellent glare control.

Le Caliber 52 est un luminaire à LED compact, à encastrer dans le sol et très efficace, il est conçu avec des optiques excellentes pour une flexibilité complète. Fabriqué en acier AISI316L et avec un degré de protection IP68, le Caliber 52 ne nécessite pas de système de drainage de l'eau. Le Caliber 52 intègre le système Smart Shield de unonovesette, ainsi qu'un driver à courant constant intégré qui permet d'alimenter le luminaire en parallèle avec une alimentation à tension constante de 12Vdc à 24Vdc. Facilement dimmable avec les systèmes DALI ou DMX en 24Vdc. Un boîtier d'encastrement ou des ressorts de montage sont disponibles pour faciliter l'installation au sol. Avec une électronique conçue en interne et bien positionnée, le Caliber 52 offre un excellent contrôle de l'éblouissement.

TECHNICAL DATA / FICHE TECHNIQUE:

 IP68	 2200K / 2700K / 3000K / 4000K
 2W	 10° / 23° / 43° / 10°x40° / Satin
 140 lm (3000K)	 Smart Shield
 >90	
	

FINISHES / FINITIONS:

	Stainless steel AISI316L Acier INOX AISI316L
	Machined aged solid brass Laiton vieilli

OPTICS / FAISCEAU:

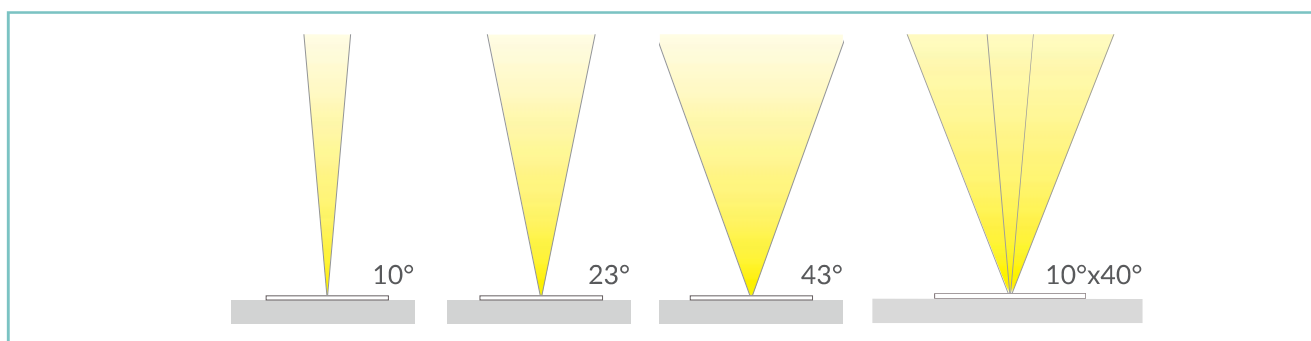



unonovessette

PRODUCT CODE/CODE PRODUIT:

C52 = CALIBER 52		Select one component from each column to specify a complete configuration: Sélectionner un composant pour chaque colonne pour une configuration complète:			
		LED colour / Couleur LED	Optics / Faisceau	Finish / Finitions	
		22 = 2200K 27 = 2700K 30 = 3000K 40 = 4000K	N = 10° M = 23° W = 43° E = 10°x40° S = Satin / Satiné	03 = Stainless steel AISI316L / Acier INOX AISI316L 10 = Aged Brass / Laiton vieilli	

Standard configuration example/
Exemple de configuration standard:

C52.30.N.03 Caliber 52 3000K 10° optics stainless steel / Acier INOX

POWER SUPPLIES 24Vdc CONSTANT VOLTAGE / ALIMENTATEUR TENSION CONSTANTE 24Vdc:



On / Off

Code / Code	Input	I Out	V Out	Watt	IP	#Caliber 52
PSU.CX.004	110+240V / 50/60 Hz	0,9 A	24Vdc	20	IP20	Max 8
PSU.CV.005	90+305V / 47/63 Hz	1 A	24Vdc	25	IP67	Max 9
PSU.CV.006	90+305V / 47/63 Hz	2,5 A	24Vdc	60	IP67	Max 25
PSU.CV.007	90+305V / 47/63 Hz	3,75 A	24Vdc	90	IP67	Max 36
PSU.CV.021	90+305V / 47/63 Hz	10 A	24Vdc	240	IP67	Max 80

Control gear / Système de control

Code / Code	Input	I Out	V Out	Watt	IP	#Caliber 52
CGE.004 - 0/1-10V	24Vdc	6,5 A	24Vdc	156	IP20	Max 70
CGE.017 - DALI	24Vdc	6,5 A	24Vdc	156	IP20	Max 70
CGE.017.IP - DALI	24Vdc	6,5 A	24Vdc	156	IP67	Max 70
CGE.020 - DMX	24Vdc	6,5 A	24Vdc	156	IP20	Max 70

ACCESSORIES / ACCESSOIRES

					
Housing Box Boîtier d'enca- strement HB.002 (80 g)	Housing Box Boîtier d'enca- strement HB.013 (320 g)	Fixing springs Ressorts de montage ACC.006	Honeycomb louver Grille nid d'abeille ACC.084	Anti-Glare louver Visière anti-éblouissement ACC.008	Cable Câble CV00037 5m CV00040 10m CV00041 15m CV00042 20m CV00043 25m

TECHNICAL DRAWING / DESSIN TECHNIQUE:

RECESSED HOLE / TROU D'ENCASTREMENT:

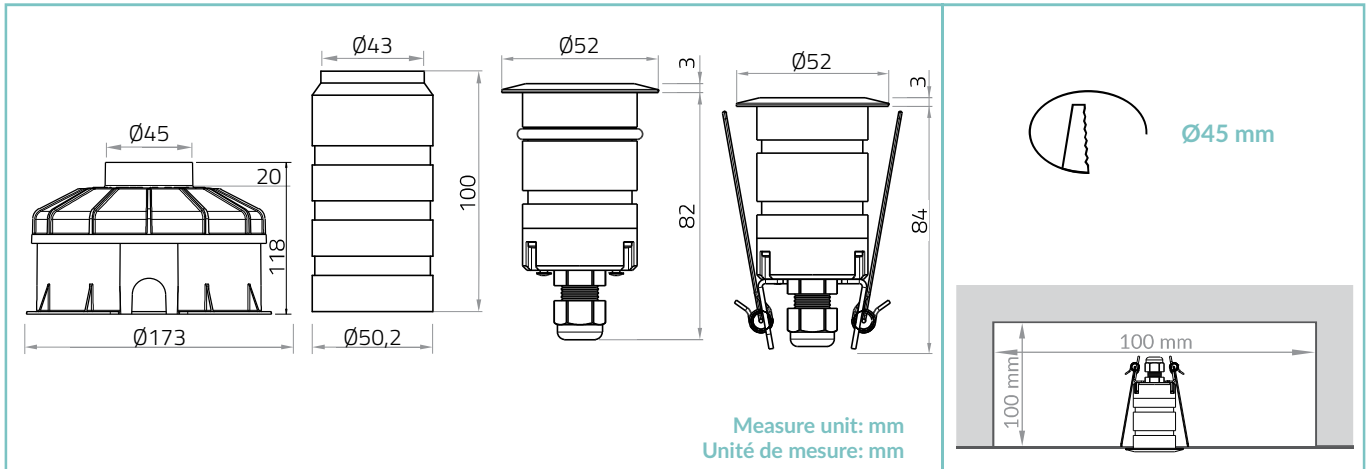

TECHNICAL SHEET / FICHE PRODUIT:

Body: Stainless Steel AISI316L - Anodized aluminium 6026 / Machined aged brass - Anodized aluminium 6026

Glass: Tempered extra clear / frosted glass 4mm

Finishes: Stainless Steel AISI316L / Aged solid brass

Installation: Housing box / Fixing Springs

Power supply cables: 35 cm NS20N PCP 2x0,5 mm²

Power supply: Constant voltage 24Vdc

Power consumption: 2 Watt

CRI: >90

Bin selection: Binning free 2 step MacAdam's

Lumenoutput (source): 140 lm (3000K)

Operating temperature: -20°C +50°C

IP rating: IP68 (not for permanent immersion)

Insulation class: Class III

Impact resistance: IK08

Weight: 280 g

Optics: 10° / 23° / 43° / 10°x40° / Satin

LED colour temperature: 2200K / 2700K / 3000K / 4000K

Lifetime LED: 100000 hrs

Photo biological risk: RG0 / RG1

Corps: Acier INOX AISI316L - Alluminium 6026 anodisé / Laiton vieilli - Alluminium 6026 anodisé

Verre: Verre temperé extra clair / Satiné 4mm

Finitions: Acier INOX AISI316L / Laiton vieilli

Installation: Boîtier d'encastrement / Ressorts de montage

Câbles d'alimentation: 35 cm NS20N PCP 2x0,5 mm²

Alimentation: Tension constante 24Vdc

Puissance absorbée: 2 Watt

IRC Indice de Rendu des Couleurs: >90

Sélection du bin: Binning free 2 step MacAdam's

Flux de la source: 140 lm (3000K)

Température de fonctionnement: -20°C +50°C

Indice de protection: IP68 (pas en immersion permanente)

Classe d'isolation: Classe III

Indice de résistance: IK08

Poids: 280 g

Optiques: 10° / 23° / 43° / 10°x40° / Satiné

Couleur LED: 2200K / 2700K / 3000K / 4000K

Durée moyenne LED: 100000 hrs

Sécurité photobiologique: RG0 / RG1

PHOTOMETRICS / COURVES PHOTOMETRIQUE:

10° - 2 Watt

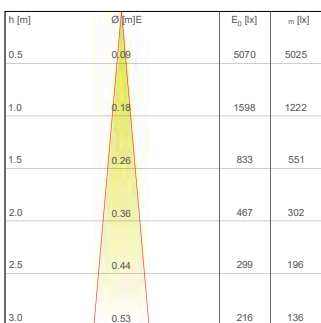

23° - 2 Watt

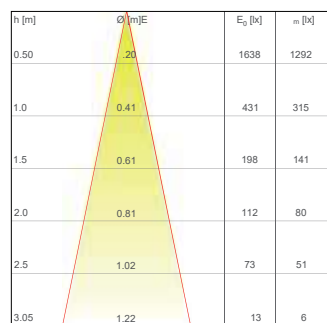

43° - 2 Watt

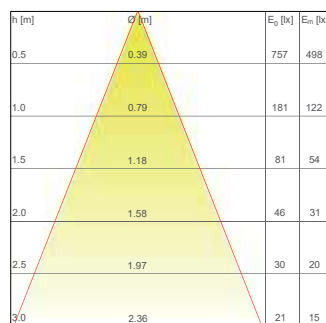

10°x40° - 2 Watt

