



IP68



CALIBER 25

Caliber 25 is an extremely efficient miniature in-ground LED uplight, designed for optical excellence and engineered for complete resilience. Caliber 25 renders an additional draining system as unnecessary. Caliber 25 features the unonovesette Smart Shield system, complete with an integrated constant current driver, which allows the luminaire to be powered in parallel with 24Vdc constant voltage power supply. Easy dimming is supported via a 24Vdc dimmable power supply or by a DALI or DMX system. A housing box accessory is available for convenient ground installation.

Caliber 25 è un apparecchio a LED dalle dimensioni ridotte da incasso a pavimento ed estremamente efficiente. Ideato con un'ottica eccellente e progettato per una completa flessibilità. Caliber 25 non necessita di sistema di drenaggio dell'acqua. Caliber 25 incorpora il sistema Smart Shield di unonovesette, oltre a un driver in corrente costante integrato che permette al corpo illuminante di essere alimentato in parallelo con un alimentatore a tensione costante a 24Vdc. Facilmente dimmerabile con sistemi a 24Vdc dimmerabili DALI o DMX. È disponibile un accessorio cassaforma per facilitare l'installazione a terra.

TECHNICAL DATA / DATI TECNICI:

 IP68

 2W

 140 lm (3000K)

 A++

 CRI >90

 2200K / 2700K / 3000K / 4000K

 10° / 40° / Satin



 Smart Shield

FINISHES / FINITURE:

 Stainless steel AISI316L
Acciaio INOX AISI316L

OPTICS / OTTICHE:

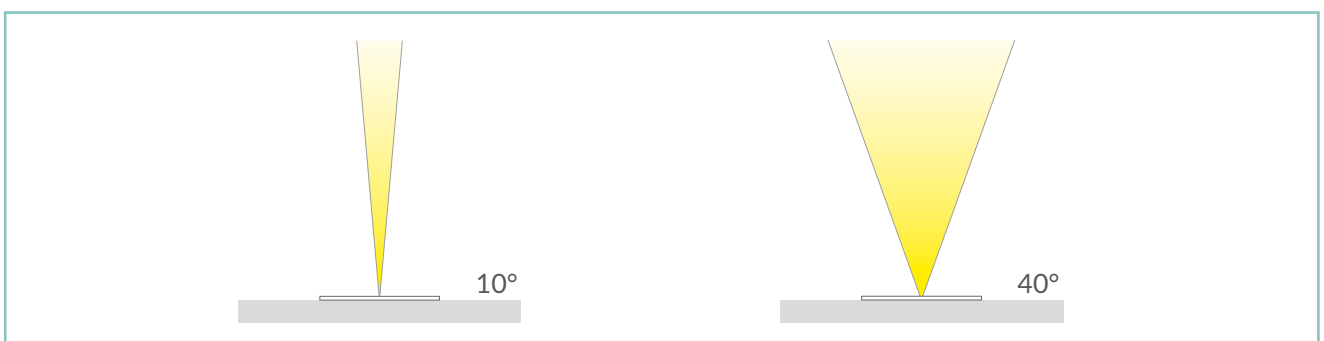



unonovesette

PRODUCT CODE / CODICE PRODOTTO:

C25 = CALIBER 25		Select one component from each column to specify a complete configuration: <i>Selezionare un componente per ogni colonna per la configurazione completa:</i>			
	LED colour / Colore LED	Optics / Ottiche	Finish / Finiture		
	22 = 2200K 27 = 2700K 30 = 3000K 40 = 4000K	N = 10° W = 40° S = Satin/Satinato	03 = Stainless steel AISI316L / Acciaio INOX AISI316L		

Standard configuration example/
Esempio di configurazione standard:

C25.30.N.03 Caliber 25 3000K 10° optics stainless steel / Acciaio INOX

POWER SUPPLIES 24Vdc CONSTANT VOLTAGE / ALIMENTATORE TENSIONE COSTANTE 24Vdc:



On / Off

Code / Codice	Input	I Out	V Out	Watt	IP	#Caliber 25
PSU.CX.004	110+240V / 50/60 Hz	0,9 A	24Vdc	20	IP20	Max 8
PSU.CV.005	90+305V / 47/63 Hz	1 A	24Vdc	25	IP67	Max 10
PSU.CV.006	90+305V / 47/63 Hz	2,5 A	24Vdc	60	IP67	Max 25
PSU.CV.007	90+305V / 47/63 Hz	3,75 A	24Vdc	90	IP67	Max 36

Control gear / *Elettronica di controllo*

Code / Codice	Input	I Out	V Out	Watt	IP	#Caliber 25
CGE.004 - 0/1-10V	24Vdc	6,5 A	24Vdc	156	IP20	Max 70
CGE.017 - DALI	24Vdc	6,5 A	24Vdc	156	IP20	Max 70
CGE.017.IP - DALI	24Vdc	6,5 A	24Vdc	156	IP67	Max 70
CGE.020 - DMX	24Vdc	6,5 A	24Vdc	156	IP20	Max 70

ACCESSORIES / ACCESSORI

		
Housing Box <i>Cassaforma</i> HB.001 (20 g)	Fixing springs <i>Molle di fissaggio</i> ACC.005	CV00044 CV00045 CV00046 CV00047 CV00048
		Cable Cavo 5m 10m 15m 20m 25m

CALIBER 25

TECHNICAL DRAWING / DISEGNO TECNICO:

RECESSED HOLE / FORO INCASSO:

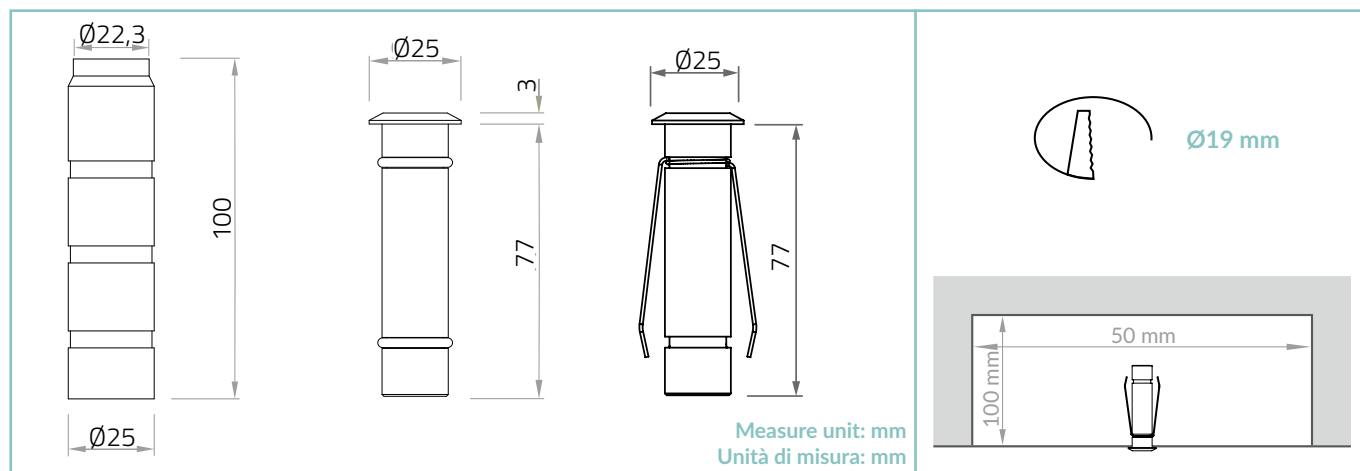

TECHNICAL SHEET / SCHEDA PRODOTTO:

Body: Stainless Steel AISI316L - Anodized aluminium 6026
Glass: Extra clear / frosted glass 2mm
Finishes: Stainless Steel AISI316L
Installation: Housing box / Fixing Springs
Power supply cables: 35 cm NS20N PCP 2x0,5 mm²
Power supply: Constant voltage 24Vdc
Power consumption: 2 Watt
CRI: >90
Bin selection: Binning free 2 step MacAdam's
Lumenoutput (source): 140 lm (3000K)
Operating temperature: -20°C +50°C
IP rating: IP68 (not for permanent immersion)
Insulation class: Class III
Impact resistance: IK05
Weight: 110 g
Optics: 10° / 40° / Satin
Energy rating: A++
LED colour temperature: 2200K / 2700K / 3000K / 4000K
Lifetime LED: 100000 hrs
Photo biological risk: RGO / RG1

Corpo: Acciaio INOX AISI316L - Alluminio 6026 anodizzato
Vetro: Vetro extrachiaro / satinato 2 mm
Finiture: Acciaio INOX AISI316L
Fissaggio: Cassaforma / Molle di fissaggio
Cavo di alimentazione: 35 cm NS20N PCP 2x0,5 mm²
Alimentazione: Tensione costante 24Vdc
Potenza assorbita: 2 Watt
CRI: >90
Selezione bin: Binning free 2 step MacAdam's
Flusso luminoso (sorgente): 140 lm (3000K)
Temperatura di funzionamento: -20°C +50°C
Grado di protezione: IP68 (non per immersione permanente)
Classe d'isolamento: Classe III
Protezione impatto: IK05
Peso: 110 g
Ottiche: 10° / 40° / Satinato
Energy rating: A++
Temperatura colore LED: 2200K / 2700K / 3000K / 4000K
Vita media LED: 100000 hrs
Rischio fotobiologico: RGO / RG1

PHOTOMETRICS / CURVE FOTOMETRICHE:

10° - 2 Watt

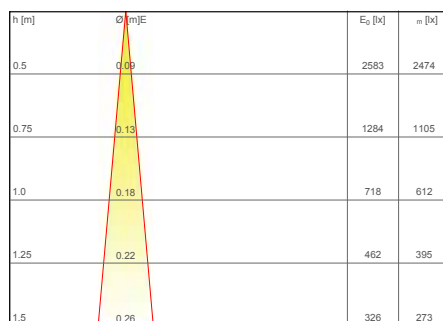

40° - 2 Watt

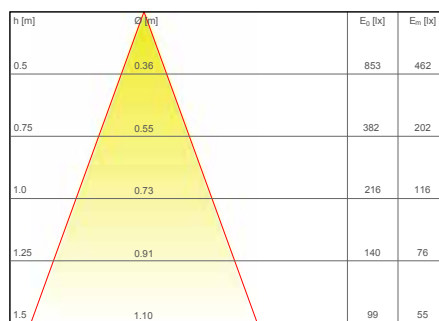

— C0 - C180 (10,0°)

— C0 - C180 (40,0°)