







IP65

CROSS 33

Cross 33 is a compact recessed LED wall-light, designed to light corridors, path ways or as night light next to entrance doors. The Cross 33 features a handcrafted flamed bronze finish and is also available in anodized black or white. Cross 33 features the unonovesette Smart Shield system, complete with an integrated constant current driver, which allows the luminaire to be powered in parallel with a 24Vdc constant voltage power supply. Easy dimming is supported via a 0/1-10V, DALI or DMX system. A housing box accessory is available for convenient installation in concrete walls.

Cross 33 è un'applicazione LED da incasso compatta, progettata per illuminare corridoi, percorsi o come luce notturna accanto alle porte d'ingresso. Il Cross 33 presenta una finitura artigianale in ottone brunito ed è disponibile anche in nero anodizzato o bianco. Cross 33 è dotato del sistema Smart Shield di unonovesette, completo di driver a corrente costante integrato, che permette di alimentare l'apparecchio in parallelo con un'alimentazione a tensione costante 24Vdc. La dimmerazione è supportata tramite un sistema 0/1-10V, DALI o DMX. È disponibile una cassaforma per una comoda installazione in pareti di cemento.

TECHNICAL DATA / DATI TECNICI:

 IP65	 2700K / 3000K
 2W	 Asymmetric
 140 lm (3000K)	 Smart Shield
 >90	
	

FINISHES / FINITURE:

	Black anodized Anodizzato nero
	Natural anodized Anodizzato naturale
	Flamed bronze Bronzo brunito

OPTICS / OTTICHE:

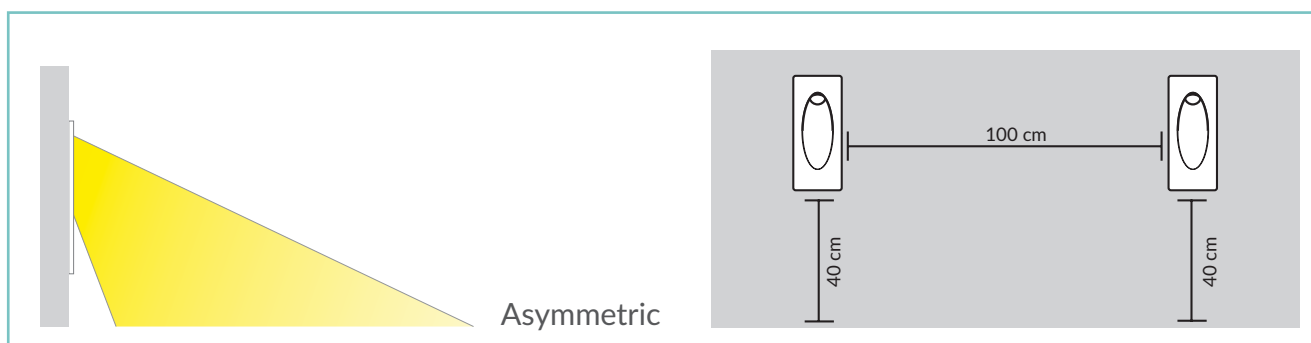

unonovasette



unonovasette

PRODUCT CODE / CODICE PRODOTTO:

CRO = CROSS 33		Select one component from each column to specify a complete configuration: Selezionare un componente per ogni colonna per la configurazione completa:			
	LED colour / Colore LED	Optics / Ottiche	Finish / Finiture	Power / Potenza	
	27 = 2700K 30 = 3000K	A = Asymmetric / Asimmetrico	05 = Black anodized / Anodizzato nero 07 = Natural anodized / Anodizzato naturale 16 = Flamed bronze / Bronzo brunito	02 = 2W	

Standard configuration example/
Esempio di configurazione standard:

CRO.30.A.05.02 Cross 33 3000K asymmetric optics black anodized / Anodizzato nero 2W

POWER SUPPLIES 24Vdc CONSTANT VOLTAGE / ALIMENTATORE TENSIONE COSTANTE 24Vdc:

On / Off

Code / Codice	Input	I Out	V Out	Watt	IP	#Cross 33
PSU.CX.004	110+240V / 50/60 Hz	0,9 A	24Vdc	20	IP20	Max 8
PSU.CV.005	90+305V / 47/63 Hz	1 A	24Vdc	25	IP67	Max 9
PSU.CV.006	90+305V / 47/63 Hz	2,5 A	24Vdc	60	IP67	Max 25
PSU.CV.007	90+305V / 47/63 Hz	3,75 A	24Vdc	90	IP67	Max 36
PSU.CV.021	90+305V / 47/63 Hz	10 A	24Vdc	240	IP67	Max 80

Control gear / Elettronica di controllo

Code / Codice	Input	I Out	V Out	Watt	IP	#Cross 33
CGE.004 - 0/1-10V	24Vdc	6,5 A	24Vdc	156	IP20	Max 70
CGE.017 - DALI	24Vdc	6,5 A	24Vdc	156	IP20	Max 70
CGE.017.IP - DALI	24Vdc	6,5 A	24Vdc	156	IP67	Max 70
CGE.020 - DMX	24Vdc	6,5 A	24Vdc	156	IP20	Max 70

ACCESSORIES / ACCESSORI

	
Housing box Cassaforma HB.004 (30g)	CV00037 CV00040 CV00041 CV00042 CV00043 Cable Cavo 5m 10m 15m 20m 25m

TECHNICAL DRAWING / DISEGNO TECNICO:

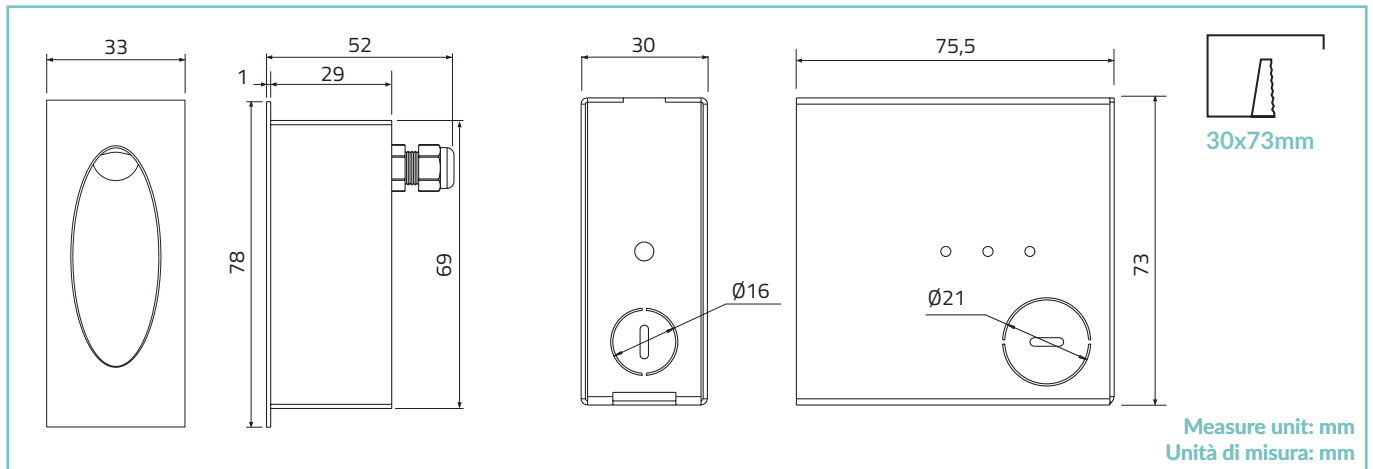

TECHNICAL SHEET / SCHEDA PRODOTTO:

Body:	Anodized aluminium 6026
Finishes:	Black anodized / Natural anodized / Flamed bronze
Installation:	Housing box / Fixing springs
Power supply cables:	35cm NS20N PCP 2x0,5mm ²
Power supply:	Constant voltage 24Vdc
Power consumption:	2 Watt
CRI:	>90
Bin selection:	Binning free 2 step MacAdam's
Lumen output (source):	140 lm (3000K)
Lumen output (delivered):	113 lm (3000K)
Operating temperature:	-20°C +50°C
IP rating:	IP65
Insulation class:	Class III
Weight:	200g
Optics:	Asymmetric
LED colour temperature:	2700K / 3000K
Lifetime LED:	50000h L95 B10 (Ta 25°C)
Photo biological risk:	RG0 / RG1

Corpo:	Alluminio anodizzato 6026
Finiture:	Anodizzato nero / Anodizzato naturale / Bronzo brunito
Fissaggio:	Cassaforma / Molle di fissaggio
Cavo di alimentazione:	35cm NS20N PCP 2x0,5mm ²
Alimentazione:	Tensione costante 24Vdc
Potenza assorbita:	2 Watt
CRI:	>90
Selezione bin:	Binning free 2 step MacAdam's
Flusso sorgente:	140 lm (3000K)
Flusso apparecchio:	113 lm (3000K)
Temperatura di funzionamento:	-20°C +50°C
Grado di protezione:	IP65
Classe d'isolamento:	Classe III
Peso:	200g
Ottiche:	Asimmetrico
Temperatura colore LED:	2700K / 3000K
Vita media LED:	50000h L95 B10 (Ta 25°C)
Rischio fotobiologico:	RG0 / RG1

PHOTOMETRICS / CURVE FOTOMETRICHE:

Asymmetric - 2 Watt

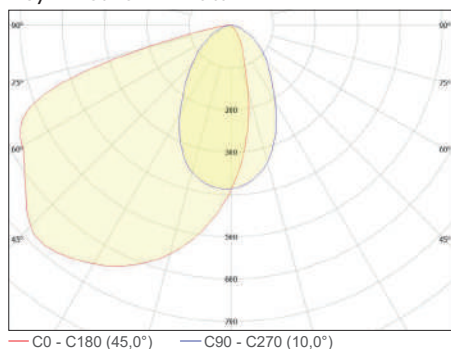

— C0 - C180 (45,0°) — C90 - C270 (10,0°)