











IP68

CALIBER 80 Q

Caliber 80 Q is an extremely efficient compact in-ground LED uplight, designed for optical excellence and engineered for complete resilience. Caliber 80 Q offers a choice of three colour temperatures as standard (2700K, 3000K and 4000K) and delivers 90 CRI for excellent colour rendering, and with binning-free LEDs carefully selected from two-step MacAdam's ellipses, colour consistency is assured throughout the unonovesette portfolio. With a deep recess of the in-house designed PCB, Caliber 80 Q offers excellent glare control. Available with a choice of three beam angles (10, 30 and 50°) and satin.

Caliber 80 Q est un luminaire à LED compact, à encastrer au sol et très efficace. Conçu avec d'excellentes optiques et pour une flexibilité complète. Construit en acier AISI316L et doté d'un dissipateur de chaleur en aluminium anodisé noir avec un indice de protection IP68, le Caliber 80 Q ne nécessite pas de système de drainage de l'eau. Le Caliber 80 Q incorpore le système Smart Shield, ainsi qu'un driver en courant constant intégré qui permet d'alimenter le luminaire en parallèle avec une alimentation à tension constante de 24 Vdc. Facilement dimmable avec les systèmes DALI ou DMX en 24Vdc. Un boîtier d'encastrement ou des Ressorts de montage sont disponibles pour faciliter l'installation au sol.

TECHNICAL DATA / FICHE TECHNIQUE:

 IP68	 2700K / 3000K / 4000K / RGBW
 5W / 9W / 4x700mA RGBW	 10° / 30° / 50° / Satin / 35° RGBW
 647 lm / 896 lm (3000K)	 Smart Shield
 >90	
	

FINISHES / FINITIONS:

 Stainless steel AISI316L Acier INOX AISI316L

OPTICS / OPTIQUE:

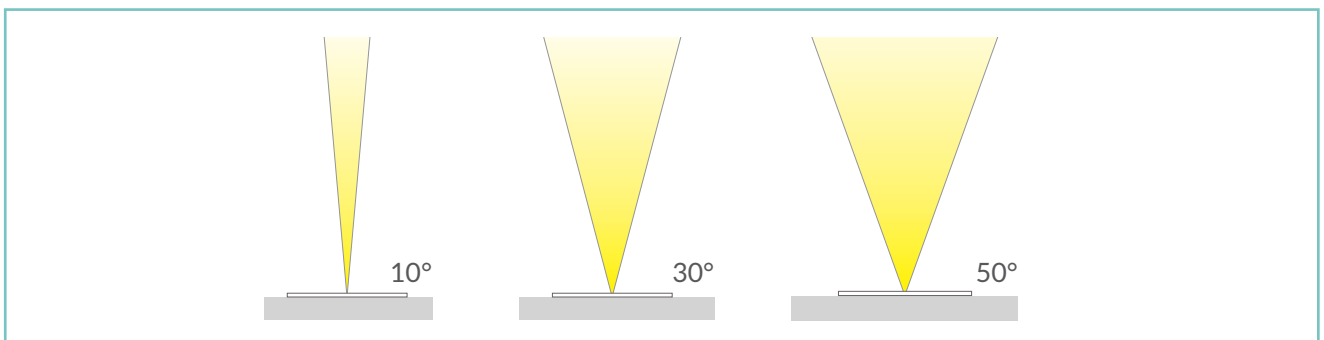



unonovessette

PRODUCT CODE/CODE PRODUIT:

C8Q = CALIBER 80 Q		Select one component from each column to specify a complete configuration: Sélectionner un composant pour chaque colonne pour une configuration complète:			
	LED colour / Couleur LED	Optics / Optique	Finish / Finitions	Power / Puissance	
	27 = 2700K 30 = 3000K 40 = 4000K FC = RGBW	N = 10° M = 30° (35° RGBW) W = 50° S = Satin / Satiné	03 = Stainless steel AISI316L / Acier INOX AISI316L	05 = 5W 09 = 9W CC = 4x700mA RGBW	

Standard configuration example/
Exemple de configuration standard:

C8Q.30.N.03.09 Caliber 80 Q 3000K 10° optics stainless steel / Acier INOX 9W

POWER SUPPLIES 24Vdc CONSTANT VOLTAGE / ALIMENTATEUR TENSION CONSTANTE 24Vdc:

On / Off 9W

Code / Code	Input	I Out	V Out	Watt	IP	#Caliber 80 Q
PSU.CX.004	110+240V / 50/60 Hz	0,9 A	24Vdc	20	IP20	Max 2
PSU.CV.005	90+305V / 47/63 Hz	1 A	24Vdc	25	IP67	Max 2
PSU.CV.006	90+305V / 47/63 Hz	2,5 A	24Vdc	60	IP67	Max 5
PSU.CV.007	90+305V / 47/63 Hz	3,75 A	24Vdc	90	IP67	Max 8
PSU.CV.021	90+305V / 47/63 Hz	10 A	24Vdc	240	IP67	Max 20





Control gear / Système de control 9W

Code / Code	Input	I Out	V Out	Watt	IP	#Caliber 80 Q
CGE.004 - 0/1-10V	24Vdc	6,5 A	24Vdc	156	IP20	Max 14
CGE.017 - DALI	24Vdc	6,5 A	24Vdc	156	IP20	Max 14
CGE.017.IP - DALI	24Vdc	6,5 A	24Vdc	156	IP67	Max 14
CGE.020 - DMX	24Vdc	6,5 A	24Vdc	156	IP20	Max 14

Control gear / Système de control RGBW

Code / Code	Input	I Out	V Out	Watt	IP	#Caliber 80 Q
CGE.005 - DMX RGBW	24Vdc	4x700 mA	24Vdc	67,2	IP20	Max 6

ACCESSORIES / ACCESSOIRES

				
Housing box Boîtier d'encastrement HB.003 (170g)	Housing box IP Boîtier d'encastrement IP HB.014 (320g)	Fixing springs Ressorts de montage ACC.007	Honeycomb louver Grille nid d'abeille ACC.004	Cable Câble CV00037 5m CV00040 10m CV00041 15m CV00042 20m CV00043 25m

TECHNICAL DRAWING / DESSIN TECHNIQUE:

RECESSED HOLE / TROU D'ENCASTREMENT:

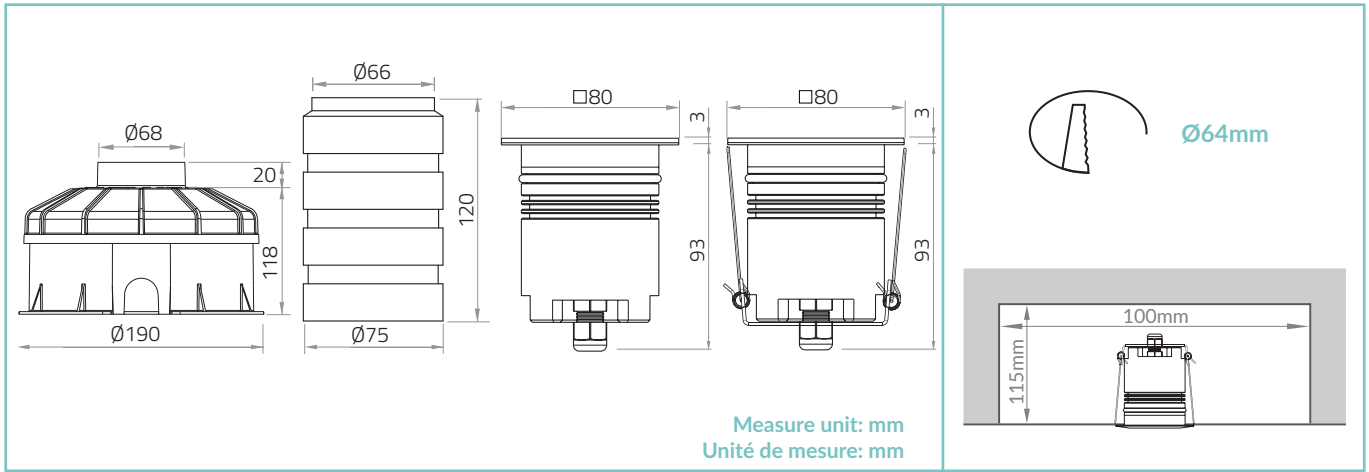

TECHNICAL SHEET / FICHE PRODUIT:

Body: Stainless Steel AISI316L - Anodized aluminium 6026

Glass: Tempered extra clear / frosted glass 6mm

Finishes: Stainless Steel AISI316L

Installation: Housing box / Fixing Springs

Power supply cables: 35cm NS20N PCP 2x0,5mm²
35cm 8x0,22mm² RGBW

Power supply: Constant voltage 24Vdc
Constant current 4x700mA RGBW

Power consumption: 5 Watt / 9 Watt / 9 Watt RGBW

CRI: >90

Bin selection: Binning free 2 step MacAdam's

Lumen output (source): 647 lm / 896 lm (3000K)

Lumen output (delivered): 409 lm / 590 lm (3000K)

Operating temperature: -20°C +50°C

IP rating: IP68 (not for permanent immersion)

Insulation class: Class III

Impact resistance: IK08

Weight: 640g

Optics: 10° / 30° / 50° / Satin / 35° RGBW

LED colour temperature: 2700K / 3000K / 4000K / RGBW

Lifetime LED: 50000h L95 B10 (Ta 25°C)

Photo biological risk: RG0 / RG1

Corps: Acier INOX AISI316L - Aluminium anodisé 6026

Verre: Verre trempé extra clair ou satiné 6mm

Finitions: Acier INOX AISI316L

Installation: Boîtier d'encastrement / Ressorts de montage

Câbles d'alimentation: 35cm NS20N PCP 2x0,5mm²
35cm 8x0,22mm² RGBW

Alimentation: Tension constante 24Vdc
Courant constante 4x700mA RGBW

Puissance absorbée: 5 Watt / 9 Watt / 9 Watt RGBW

IRC Indice de Rendu des Couleurs: >90

Sélection du bin: Binning free 2 step MacAdam's

Flux lumineux (source): 647 lm / 896 lm (3000K)

Flux lumineux (sortant): 409 lm / 590 lm (3000K)

Température de fonctionnement: -20°C +50°C

Indice de protection: IP68 (pas en immersion permanente)

Classe d'isolation: Classe III

Indice de résistance: IK08

Poids: 640g

Optiques: 10° / 30° / 50° / Satiné / 35° RGBW

Couleur LED: 2700K / 3000K / 4000K / RGBW

Durée moyenne LED: 50000h L95 B10 (Ta 25°C)

Sécurité photobiologique: RG0 / RG1

PHOTOMETRICS / COURVES PHOTOMETRIQUE:

10° - 9 Watt

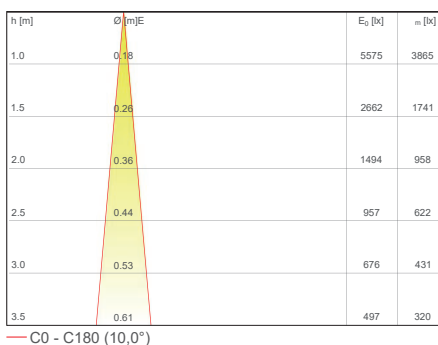

30° - 9 Watt

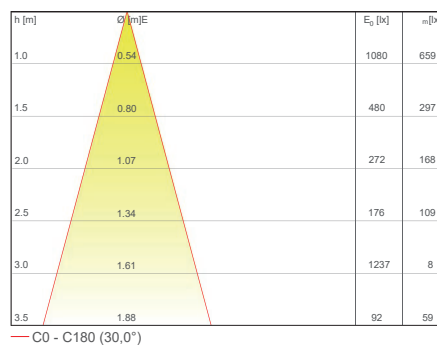

50° - 9 Watt

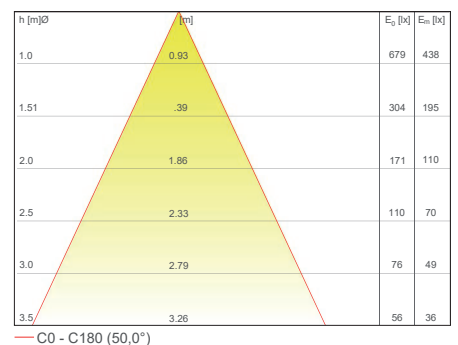



9 Schiedamschen
Kantoorplein

LEER + KOKIES

5049m



Project: Tram Station Leyweg
Location: The Hague, The Netherlands