



IP68









CALIBER 25 XS

Caliber 25 XS is an extremely efficient miniature in-ground LED up- light with a height of only 35mm, designed for optical excellence and engineered for complete resilience.



Caliber 25 XS renders an additional draining system as unnecessary. Caliber 25 XS offers a choice of four colour temperatures as standard (2200K, 2700K, 3000K and 4000K) and delivers 90CRI for excellent colour rendering, and with binning-free LEDs carefully selected from two-step MacAdam's ellipses, colour consistency is assured throughout the unonovesette portfolio.

Caliber 25 XS è un apparecchio a LED dalle dimensioni ridotte, con un'altezza di solo 35mm da incasso a pavimento ed estremamente efficiente. Ideato con un'ottica eccellente e progettato per una completa flessibilità. Caliber 25 XS non necessita di sistema di drenaggio dell'acqua. Caliber 25 XS offre una scelta fra quattro temperature di colore come standard (2200K, 2700K, 3000K e 4000K) tutte con CRI maggiore di 90 per una eccellente resa cromatica. Binning-free e due-step MacAdam's ellipses LED, assicurano consistenza del colore in tutte le versioni previste da unonovesette.

TECHNICAL DATA / DATI TECNICI:

 IP68	 2200K / 2700K / 3000K / 4000K
 1W	 10° / 40° / Satin
 110 lm (3000K)	 Smart Shield
 >90	
	

FINISHES / FINITURE:

	Stainless steel AISI316L Acciaio INOX AISI316L
	Black anodized Anodizzato nero
	Natural anodized Anodizzato naturale

OPTICS / OTTICHE:

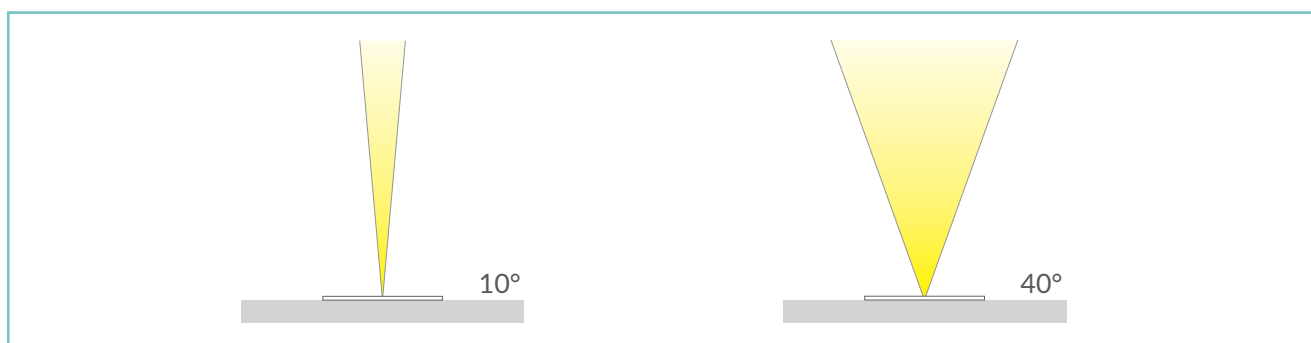

unonovasette

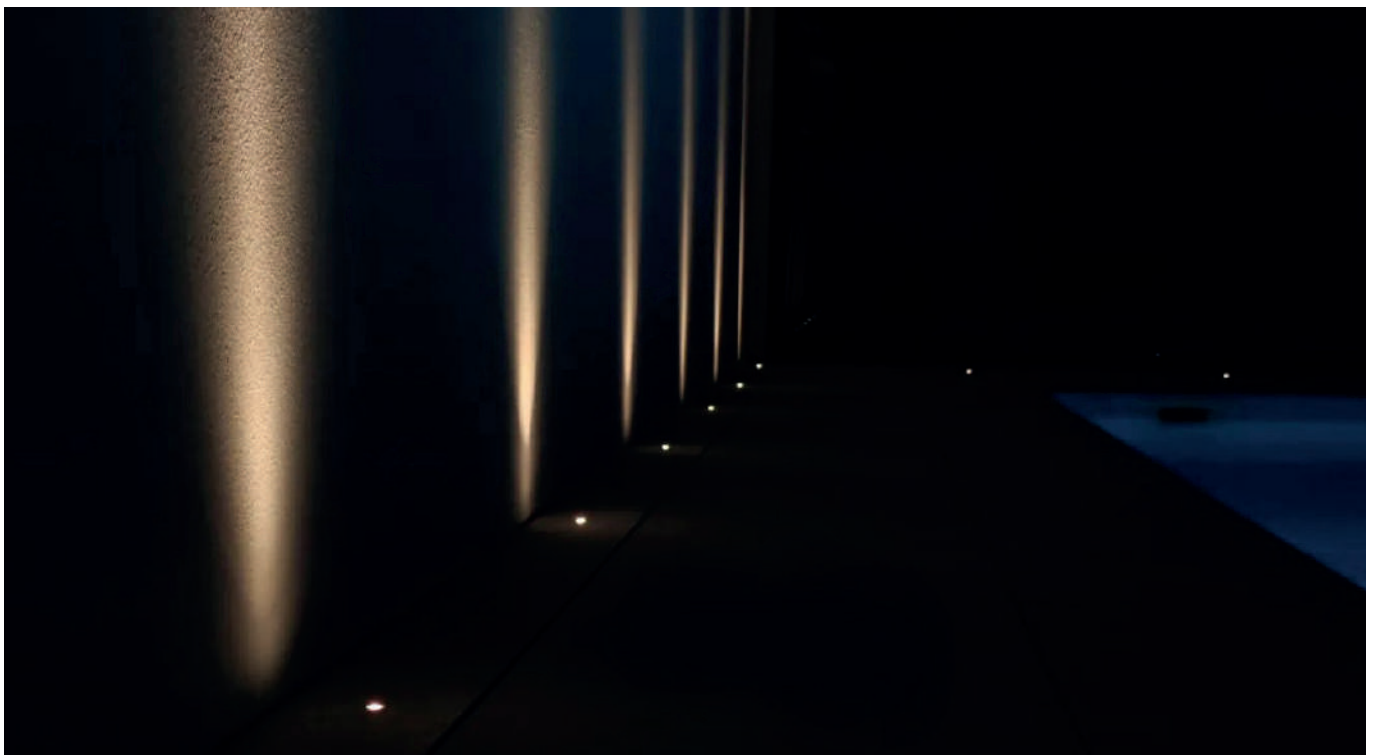

unonovesette

PRODUCT CODE / CODICE PRODOTTO:

CXS = CALIBER 25 XS 	Select one component from each column to specify a complete configuration: Selezionare un componente per ogni colonna per la configurazione completa:			
	LED colour / Colore LED	Optics / Ottiche	Finish / Finiture	Power / Potenza
22 = 2200K 27 = 2700K 30 = 3000K 40 = 4000K	N = 10° W = 40° S = Satin / Satinato	03 = Stainless steel / Acciaio INOX AISI316L 05 = Black anodized / Anodizzato Nero 07 = Natural anodized / Anodizzato naturale	CC = 350mA	

Standard configuration example/
 Esempio di configurazione standard:

CXS.30.N.03.CC Caliber 25 XS 3000K 10° optics stainless steel / Acciaio INOX 350mA

POWER SUPPLIES 350mA CONSTANT CURRENT / ALIMENTATORE CORRENTE COSTANTE 350mA:



On / Off

Code / Codice	Input	I Out	V Out	Watt	IP	#Caliber 25 XS
PSU.CC.002	100+240V / 50/60 Hz	350mA	36 V	12	IP20	Max 9
PSU.CC.003	100+240V / 50/60 Hz	350mA	43 V	15	IP20	Max 12
PSU.CC.014	100+240V / 50/60 Hz	350mA	24 V	8	IP20	Max 6
PSU.CX.004	110+240V / 50/60 Hz	350mA	43 V	15	IP20	Max 12

Dimmable / Dimmerabile

Code / Codice	Input	I Out	V Out	Watt	IP	#Caliber 25 XS
PSU.CX.001 1-10V/PUSH	110+240V / 50/60 Hz	350mA	47 V	15	IP20	Max 12
PSU.CC.022 DALI	110+240V / 50/60 Hz	350mA	40 V	20	IP20	Max 12

ACCESSORIES / ACCESSORI

 <p>Housing box Cassaforma HB.005 (10g)</p>	 <p>Fixing springs Molle di fissaggio ACC.049</p>	 <p>Cable Cavo 5m 10m 15m 20m 25m</p>
--	--	--

CALIBER 25 XS

TECHNICAL DRAWING / DISEGNO TECNICO:

RECESSED HOLE / FORO INCASSO:

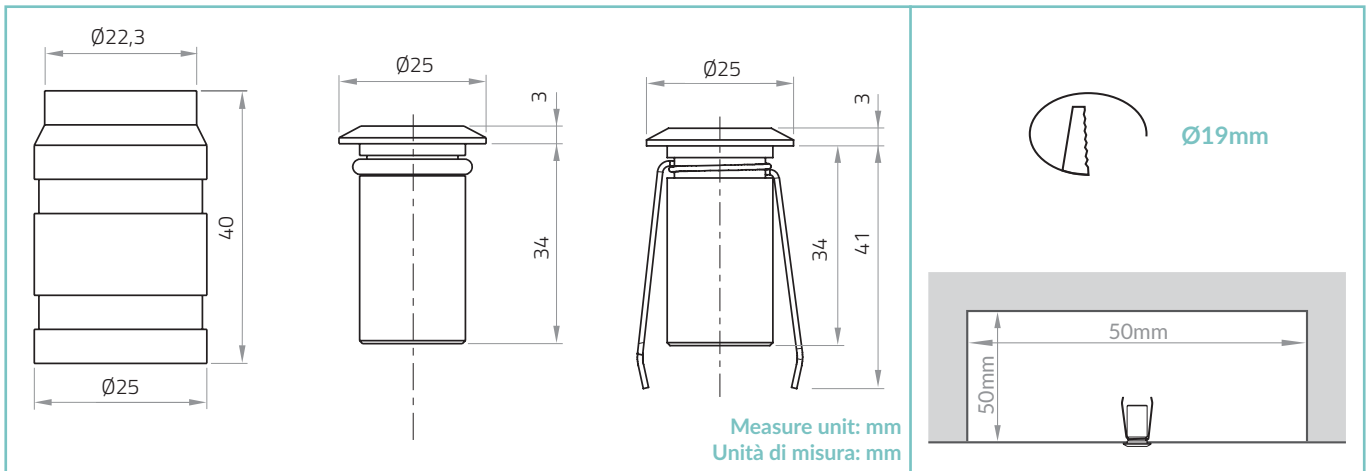

TECHNICAL SHEET / SCHEDA PRODOTTO:

Body: Stainless Steel AISI316L - Anodized aluminium 6026
Glass: Extra clear / frosted glass 2mm
Finishes: Stainless Steel AISI316L / Black anodized / Natural anodized
Installation: Housing box / Fixing Springs
Power supply cables: 35cm NS20N PCP 2x0,5mm²
Power supply: Constant current 350mA
Power consumption: 1 Watt
CRI: >90
Bin selection: Binning free 2 step MacAdam's
Lumen output (source): 110 lm (3000K)
Lumen output (delivered): 89 lm (3000K)
Operating temperature: -20°C +50°C
IP rating: IP68 (not for permanent immersion)
Insulation class: Class III
Impact resistance: IK05
Weight: 50g
Optics: 10° / 40° / Satin
LED colour temperature: 2200K / 2700K / 3000K / 4000K
Lifetime LED: 50000h L95 B10 (Ta 25°C)
Photo biological risk: RGO / RG1

Corpo: Acciaio INOX AISI316L - Alluminio 6026 anodizzato
Vetro: Vetro extra chiaro / satinato 2mm
Finiture: Acciaio INOX AISI316L / Anodizzato nero / Anodizzato naturale
Fissaggio: Cassaforma / Molle di fissaggio
Cavo di alimentazione: 35cm NS20N PCP 2x0,5mm²
Alimentazione: Corrente costante 350mA
Potenza assorbita: 1 Watt
CRI: >90
Selezione bin: Binning free 2 step MacAdam's
Flusso sorgente: 110 lm (3000K)
Flusso apparecchio: 89 lm (3000K)
Temperatura di funzionamento: -20°C +50°C
Grado di protezione: IP68 (non per immersione permanente)
Classe d'isolamento: Classe III
Protezione impatto: IK05
Peso: 50g
Ottiche: 10° / 40° / Satinato
Temperatura colore LED: 2200K / 2700K / 3000K / 4000K
Vita media LED: 50000h L95 B10 (Ta 25°C)
Rischio fotobiologico: RGO / RG1

PHOTOMETRICS / CURVE FOTOMETRICHE:

10° - 1 Watt

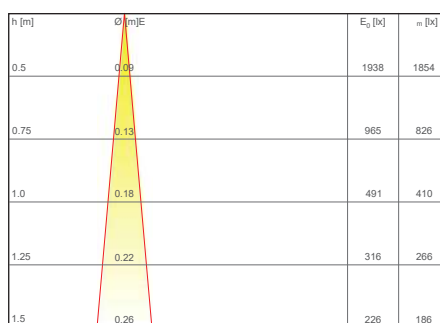

— CO - C180 (10,0°)

40° - 1 Watt

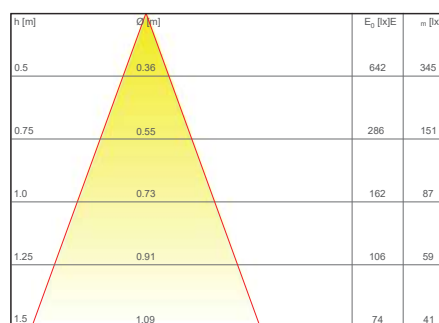

— CO - C180 (40,0°)